



# THE ANIMAL WELFARE INSTITUTE QUARTERLY

P.O. BOX 3650

WASHINGTON, DC 20007

WINTER 1988

VOL. 36, NO. 4

## To Jane Goodall from John Melcher: The Albert Schweitzer Medal

The world's most distinguished and ardent friend of chimpanzees, Jane Goodall, was awarded the 1987 Schweitzer Medal of the Animal Welfare Institute at the annual meeting 2 December 1987. Senator John Melcher (D, MT), who presented the medal, made a moving and powerful speech. He said Dr. Goodall was only matched by its first recipient, Albert Schweitzer."

The Senator's personal commitment to the welfare of chimpanzees and other animals shone through all his remarks. "The Creator expects us, as the dominant species with the greatest intelligence, to respect all other species," he said. The only veterinarian ever to serve in the US Senate, Senator Melcher is the author of the provision for "a physical environment adequate to promote the psychological well-being of primates" in the Improved Standards for Laboratory Animals Amendments. He adjured the Department of Agriculture to promulgate regulations faithful to the legislation enacted by the Congress.

Dr. Goodall was introduced to the way animals are treated by visits to two commercial laboratories: SEMA, in Maryland, which operates under a contract with the National Institutes of Health, and, in Vienna, Austria, IMMUNO. Emphasizing the impact of "actually seeing with your own eyes," she described the SEMA cages, 22 inches by 22 inches by 24 inches, in which pairs of infant chimpanzees are confined. "Those particular youngsters weren't under experimentation. They were waiting,

*continued on page 2*



*Jane Hughes*

*Senator John Melcher and Dr. Jane Goodall hold the Albert Schweitzer Medal.*

### INSIDE

Japanese whalers called to account ..... page 4

Lifting the curtains of death ..... page 6

Wildlife Crime and Punishment ..... page 8

Behind the scenes at the Baylor Cancer Laboratory ..... page 10

Barbarism in the food market ..... page 11

## Lacey Act regulations under fire by pet industry

The foundation stone for effective wildlife protection by the United States is the Lacey Act passed in 1900. Under its provisions, any state law or foreign law benefitting wild species must be honored throughout the United States. The heavy fines levied under its aegis have served as a deterrent to wildlife criminals.

But an essential part of the Lacey Act is now under attack by the big animal dealers because of regulations promulgated by the US Fish and Wildlife Service (FWS) under the 1981 amendments. Entitled "Humane and Healthful Transport of Wild Mammals and Birds to the United States", the regulations would require food and water to be provided, prohibit shipment of pregnant, nursing

or unweaned mammals, dropping and mishandling of crates, crating together of incompatible animals, exposure to harmful temperatures, air pressures or inadequate ventilation and require perches for birds so droppings do not fall into food or water containers or onto other birds.

These regulations, designated as *final* were published in *The Federal Register* 10 November 1987 with an effective date of 8 February 1988. But, under intense last-minute pressure from the pet industry and airlines, FWS suddenly reneged in a 10 February 1988 announcement citing possible "confusion or misinterpretation" and post-

*continued on page 9*

**Goodall receives Schweitzer Medal,** *continued from page 1*

just waiting. They could barely turn around in those tiny, cramped prisons.”

For 27 years Jane Goodall has observed chimpanzees under natural conditions. “If we can learn to understand the chimpanzee,” she said, “it will help us to understand ourselves.” She spoke of the feelings they express: joy, sorrow, rage, pain and fear, of their cognitive abilities, of their capability for directed communication as shown by language acquisition studies such as Roger Fouts’, and finally of altruism.

She chose a few poignant anecdotes from her own experience to help her intently listening audience grasp chimpanzee nature. Lucy, one of the first chimpanzees to learn American Sign Language, had been raised like a human child up to the age of ten. At their first meeting, Dr. Goodall sat down on the sofa, and “Lucy sat close to me and looked into my eyes.” Then Lucy went to get a key, with which she unlocked a cupboard, took out a bottle, poured herself “a very reasonable serving of gin and filled it up with tonic.” Next she got a magazine and leafed through it, signing to herself as she looked at the pictures.

Unfortunately, when she was ten, she suddenly lost her comfortable home. As Dr. Goodall put it, “Her ‘parents’ no longer wanted her living with them. They decided ‘We’ll give Lucy her freedom,’” and sent her back to Africa to live with other chimpanzees. “This is about the same as sending a ten year old urban girl to live with a tribe of Australian aborigines or Amazonian in-

dians.” Lucy was put into a large outdoor enclosure in the Gambia with two boisterous wild-born chimps. She went into a depression which lasted for many months.

During the early days of her new life she would sign, “Please help. Lucy wants out. Please help.” Later she was found dead, with her hands and feet cut off.

Example after example of courageous, altruistic be-



*Albert Schweitzer holds gold replica of the medal created in his honor.*



havior described by Dr. Goodall showed how chimpanzees come to the aid of friends in distress. The first was from the Gombe Stream group she has observed over generations. “Recently in Gombe, nine chimps were lost in an

epidemic, leaving two three and a half year old orphans,” she said. Dr. Goodall feared they would die, “but these two, one female, one male, have been adopted, not by older siblings, but by non-related adolescent males. One was Beethoven. Now 17 years old, he too had lost his mother—when he was four and a half. Little Mel was adopted by 12 year old Spindle. Both

young males share food with the orphans they have adopted, wait for them, carry them and do their best to protect them. There is no question but that these adoptions saved the lives of these two orphans,” she said.

She told how the large female, Gigi, saved the life of a young male, Freud, from an attack by the enraged wild sow whose piglet Freud had caught.

Dr. Goodall told how logging companies are destroying the forests for commercial gain, and chimpanzee ba-

---

*“If a chimpanzee—one who has been abused by humans—can reach across the species barrier to help a human friend, then surely we, with our greater capacity for compassion, can reach out to help chimpanzees, to help all the non-human creatures with whom we share this planet, can’t we?”*

---

bies are captured for entertainment and medical research around the world. The horrors involved in this trade are exemplified by her account of two native hunters she met in a hospital. They had tried to catch a baby chimp to sell it. They shot the mother,

*continued on next page*

People for the Ethical Treatment of Animals



*Chimpanzees caged at SEMA laboratory*

## A dog dealer, his clients and a judge

Eighteen months ago the Summer 1986 *Quarterly* had an article detailing the truly appalling manner in which animal dealer Ervine Stebane of Kaukauna, Wisconsin, was conducting his business. Those with strong stomachs may wish to refer back to that article but for present purposes it is sufficient to say that Stebane violated, in extreme form, almost every article of the Animal Welfare Act, that some of his animals come from unidentified sources and that distraught owners entering his "ranch" in search of their pets were likely to be viciously assaulted.

It is shocking that a man who as long ago as 1960 demonstrated his total unfitness to have charge of animals (see again Summer 1986 *Quarterly*) was able to retain his dealer's license. It is even more shocking that 28 years later, following his conviction on 16 fresh offences against the Animal Welfare Act and a blood-curdling expose of his misdeeds in the local media, Ervine Stebane is still in business.

Two very respectable, or at any rate respected, bodies, the University of Wisconsin and the Madison Area Technical College, are long-time customers of Stebane (the University uses around 1800 dogs and cats a year, 80-85% of which come from Stebane, they still say, despite all the sickening revelations, that they see no reason for leaving an "USDA-approved vendor".)

As a further shocker the judge who sentenced Stebane decided that the 16 offences (which included the vicious intimidation of an USDA inspector) merited nothing more severe than a \$1500 fine, a cease-and-desist order and the suspension of his license for just 20 days so long as his facility was by then in compliance with the Act—none of which of course has any bearing on how he handles the animals in his care or, for that matter, how he acquires them in the first place.

USDA has appealed the penalties as being insufficiently severe. The appeal is still pending, meanwhile Stebane is still operating.

## Alternatives meeting in Stockholm

An international meeting on *In Vitro methods in toxicity testing and biomedical research* will be held at the University of Stockholm, Sweden, 9-11 May. The meeting, sponsored by the Swedish Council for Laboratory Animals, will focus on developments in the field of *in vitro* assay systems and will assess the relevance of *in vitro* techniques for *in vivo* situations. The all-inclusive meeting fee is \$150.

For further information and hotel bookings, write: Mr. Sten Schager, Division of External Relations, University of Stockholm, S-106 91 Stockholm, Sweden.

## Frame receives award

Dr. Michael Balls, chairman of the Fund for the Replacement of Animals in Medical Experiments (FRAME) trustees, was awarded the 1986 Marchig Animal Welfare Award for development of *in vitro* cytotoxicology for assessing acute toxicities of chemicals at an early stage in new product development of pharmaceuticals, household products and pesticides. Entries are judged by a distinguished panel, and the award is administered by the World Society for the Protection of Animals.

## Schweitzer Medalists Dole and Foley most respected legislators

In a recent poll of 317 senior Capitol Hill aids on the most effective and respected leaders in Congress, top ratings went to House Majority Leader Tom Foley (D, WA) and Senate Minority Leader Bob Dole (R, KS), according to *The New York Times*, February 1988.

The Albert Schweitzer Medal for outstanding contributions to animal welfare was presented to Senator Dole in 1986 for his leadership in obtaining enactment of the Improved Standards for Laboratory Animals amendments to the federal Animal Welfare Act in 1985 and federal humane slaughter legislation in 1978. Representative Foley was awarded the Schweitzer Medal in 1971 after he won enactment of the 1970 Animal Welfare Act amendments.

## Goodall receives Schweitzer medal, *continued from page 2*

who fell to the ground, dying. The hunters approached her to take the terrified, screaming baby. There was a sudden explosion in the bushes, and a large male chimpanzee burst out. He seized one man by his hair, practically scalping him, flung the other man against the rocks, breaking several ribs, and then took the baby in his arms and ran off into the forest.

She told, too, of a captive chimpanzee named Old Man who had suffered long in a circus and hated people. Marc, the young man who took food to Old Man and the three adult females living with him on safari park island, eventually developed a close, friendly relationship with them. One day, however, he slipped and fell, accidentally frightening a baby, who screamed. Immediately the mother leapt at Marc and bit into his neck. The other two females rushed



Ruth Fisher

More than 300 members and friends of the Animal Welfare Institute attended the annual meeting.

to support their friend and they too bit Marc. But Old Man came charging up and pulled them away so Marc was able to drag himself into the boat and escape. "Old Man saved my life," Marc told Jane Goodall. The story is symbolic, she said. "If a chimpanzee—one who has been abused by humans—can reach across the species barrier to help a human friend, then surely we, with our greater capacity for compassion, can reach out to help chimpanzees, to help all the non-human creatures with whom we share this planet, can't we?"

# U.S. Declares Japan in Violation on Whaling and May Curb Trade

## The Dispute Over Japanese Whaling

The U.S. accused Japan of violating an international pact. Japan says the hunt for 300 whales is part of a scientific expedition.

### Where Japan Is Hunting For Minke Whales

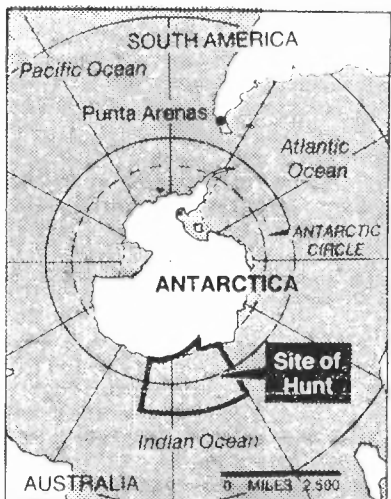

A Minke Whale

Drawing from "A Field Guide to the Whales, Porpoises and Seals," by Kristina Rough and Richardson. Illustrations copyright © 1983 Sarah Landry, D. D. Tyler, and John R. Quinn.

### Two Amendments: Recourse for U.S.

**Pelly** Gives the President discretion to impose an embargo on imports of fisheries products from the offending countries. President Reagan has 60 days to tell Congress what action, if any, he will take against Japan. Previous violators: Japan, Soviet Union (1974); Chile, Peru, South Korea (1978); Soviet Union (1985). Norway (1986). Although countries have responded to the threat of sanctions, they have never been imposed.

**Packwood-Magnuson** Calls for automatic reduction of at least 50 percent in amount of fish permitted to be taken from U.S. waters by a violating nation. Previous violator: Soviet Union (1985).

By PHILIP SHABECOFF

Special to The New York Times

WASHINGTON, Feb. 10 — Commerce Secretary C. William Verity Jr. today declared Japan in violation of a moratorium on commercial whaling. A spokesman for Mr. Verity said the Secretary might recommend an embargo on imports of fish from Japan.

With Mr. Verity's declaration, President Reagan has 60 days to inform Congress of what action he is taking. If he does not impose an embargo, he must explain his decision to Congress.

### A Hint of Retaliation

Commerce Department officials said Mr. Verity was delaying his recommendation to provide time for bargaining with the Japanese.

Because the United States sells twice as much fish to Japan as the Japanese sell in this country, an embargo could invite retaliation by Japan, a spokesman for the Japan Whaling Association,

a trade group, suggested. "Japan is America's best customer for fish," the spokesman, Alan Macnow, said.

Conservation groups and some members of Congress applauded today's decision and said they would press for an embargo.

Mr. Verity made the declaration after Japanese representatives informed him earlier this week that a three-ship whaling fleet was in Antarctic waters and would kill 300 whales.

The Japanese contend that the expedition is for scientific purposes and, therefore, that the killings of the minke whales do not violate the moratorium called by the International Whaling Commission. The minke is not an endangered species.

Mr. Verity rejected the Japanese explanation and invoked two laws that call for sanctions against any nation that "diminishes the effectiveness" of

an international fisheries agreement — in this case the whaling commission's moratorium.

[In Tokyo the head of Japan's fisheries agency, Hironao Tanaka, called the American action "extremely regrettable." His remarks, appearing in Japanese newspapers on Thursday, were strong language for a Tokyo bureaucrat. Mr. Tanaka reiterated the Japanese position that "research whaling is the right" of member nations of the International Whaling Commission.]

In the past, Japanese officials have said the killing of non-endangered whales should not be viewed as any different from the killing of cattle. Some officials have accused the United States of racial prejudice and of trying to thwart Japan's cultural prerogatives.

Whale meat accounts for a small portion of the protein consumed in Japan. About a thousand Japanese make a living directly from whaling, while 50,000 others are active in related processing and retail ventures.

One American law, the Packwood-Magnuson Amendment, calls for an automatic reduction of at least 50 percent in the amount of fish that a nation in violation of an international agreement is permitted to take from United States territorial waters.

Such a sanction would be largely symbolic since Japan was not allocated any quota in American waters this year because of low stocks. But Brian Gorman, a Commerce Department spokesman, said the sanction could take on practical importance if fish stocks rose and an allocation were available for Japan.

The second law is the Pelly Amendment, which gives the President the discretion to impose a total or partial embargo on shipments of fisheries products from offending countries.

Last year Japan sold about \$500 million of fisheries products, including \$100 million of pearls, to this country. But the United States sold more than \$1 billion of fish products, much of it salmon, to Japan.

Although the Pelly Amendment has been invoked in the past, it has never led to an embargo because the threat alone led to concessions by the country found in violation of the law.

Mr. Macnow of the Japanese Whaling Association said the Antarctic expedition did not violate the moratorium on commercial whaling. It is intended, he said, to determine the number of "surplus" minke (pronounced MINK-ee) whales — the number by which births exceed deaths. Japan is seeking this information to determine whether "the resource can be utilized," he said.

After the research is completed, the killed whales, which are 15 to 30 feet long at maturity, are brought to market. The Japanese say the sale of

whale meat subsidizes the research.

Minke whale meat usually sells in Tokyo for about \$9.80 a pound. The tail meat is considered a delicacy and is available only in small quantities, selling for about \$140 a pound.

The International Whaling Commission is conducting a mail ballot among its member nations on a British resolution declaring that the Japanese expedition has no scientific validity. A close vote is expected, and the results are due Sunday.

"The Secretary didn't even wait for the results of the ballot and rode roughshod over the rights of the Japanese," Mr. Macnow said. Mr. Verity's finding that the Japanese were diminishing the effectiveness of the whaling treaty was "an outrageous announcement," he said.

William K. Reilly, president of the World Wildlife Fund, an international conservation group, said in a statement: "It is outrageous that Japan is now slaughtering hundreds of whales in open defiance of its 1984 agreement with the United States and the Inter-

national Whaling Commission's moratorium on commercial whaling. It is doubly outrageous that Japan is attempting to justify these actions in the name of science."

Dean Wilkenson, wildlife legislative director for Greenpeace, another conservation group, hailed Mr. Verity's action, saying: "The message has now gone out: Whaling must cease. It is encouraging that the Commerce Department is following through on the long-standing U.S. policy to end commercial whaling."

The International Whaling Commission imposed the moratorium in 1986 because of evidence that the commercial hunt was severely depleting the global population of the great whales. A number of whale species, including the blue whale (the earth's biggest animal) and the sperm whale, have been reduced until their continued existence is in doubt, some whale experts say.

A lawsuit filed by conservation groups almost certainly played a role in Mr. Verity's decision, said Craig

Van Note, executive director of Monitor, a consortium of conservation and animal welfare organizations.

Also there has been considerable sentiment among members of Congress for taking action. Representative Don Bonker, Democrat from Washington, issued a statement that said in part, "Our Government must send a clear and unmistakable message to the Government of Japan to stop this slaughter."

In 1984 the United States agreed not to take legal steps against Japan even though it continued to take whales after a moratorium on sperm whales was in effect. In return Japan promised to end its whaling by 1988. In an earlier suit, conservationists tried to void that agreement, but it was upheld by the Supreme Court.

Copyright © 1988 New York Times Co. Reprinted by permission.

## Beluga whale permit denied

The Minnesota Zoo is no place for whales. That's the decision of the National Marine Fisheries Service (NMFS), which last November denied an extension of the zoo's permit to capture and display beluga whales because of its past mistreatment of belugas under their care. The action came after the environmental community submitted extensive documentation of this abuse to NMFS and is unique in the history of federal regulation of this kind. The Minnesota law firm of Faegre & Benson generously provided its services *pro bono* to the conservation community on this issue.

In the summer of 1977, the Minnesota Zoo was given a permit to capture up to four beluga whales for display and shortly thereafter captured two whales, "Big Mouth" and "Little Girl", who were transported to the zoo. NMFS routinely renewed the zoo's capture permit at two year intervals.

In July of 1984, Big Mouth, suffered a minor injury to his lower lip. Till May of 1986, a variety of treatments, primarily pharmacological, were used to aid the wound's healing. But the wound steadily worsened and became so badly infected that the zoo asked three marine mammal experts their advice on treatment, including the possibility of surgery, an option all three advised against. They suggested that moving the whale to natural sea water would be safer and

more efficacious.

But the zoo ignored their advice and performed a radical surgical procedure that had never been done before. The surgical team consisted of the zoo's veterinarian, a veterinary assistant with no marine mammal experience and three surgeons specializing in human patients. The team succeeded in removing a large portion of Big Mouth's lower jaw but the surgical site did not heal properly so a second procedure was performed on the (now partially removed) lower jaw and on other skin lesions which had developed.

During this surgery, Big Mouth was not properly anesthetized. He began thrashing about as one of the surgeons chipped into a bone on his pectoral fin in an attempt to remove a lesion with a cauterizing knife. But this surgery still did not alleviate the problem. The surgery site on his jaw did not heal and the lesions became worse.

Laboratory tests revealed ulcerative gastritis, liver and kidney damage.

A stressed whale with a minor skin problem which is correcting itself now—as marine mammal experts had earlier advised—in natural sea water, was nearly killed by a series of unnecessary surgical operations.

Fortunately, NMFS has denied the zoo's permit request for two more whales.

—Richard Duncan

## Members please note:

In the coming year, we will be asking all AWI members to renew their membership at the same time, rather than sending out renewals each month as we have done in the past. This will enable AWI staff to devote more hours to essential animal protective programs, and we will deeply appreciate your help in making the new system work for the benefit of animals.

## The lone eagle

When we named the Bald Eagle as our national bird, we really knew what we were doing. A notable example of this marvelous creature's strength, pluck, determination, spirit and luck (all good qualities for a nation) is the story of Iolar (Gaelic for eagle) who has just been released in excellent condition from Tufts University School of Veterinary Medicine. The check-up followed a flight from somewhere in North America to Ireland where he was spotted resting. He may have been helped a little by a storm blowing eastward, but it is still a remarkable feat, as well as being cheaper than any excursion rate yet.

# LIFTING THE CURTAINS OF DEATH

Two bills that will provide needed protection to marine mammals and sea birds were included, without opposition, in the US-Japan Fishery Agreement Approval Act of 1987.

Driftnets in the North Pacific cause the deaths of tens of thousands of marine mammals and hundreds of thousands of seabirds each year. The use of these "curtains of death" is not even an efficient method of catching fish. It has been estimated that one-half

through American ports. Japanese ships routinely violate geographic limits and fish in colder waters where salmon are present. Last year 96 vessels were sighted outside authorized areas. Many of the vessels had covered their identification numbers indicating that they were deliberately violating the boundaries.

To deal with this problem, the law provides that the Secretary of Commerce will enter into negotiations with

mals. Further, observer coverage for this fleet has been less than ten percent, and there is evidence that attempts have been made to manipulate that coverage. Environmentalists urged that observer coverage be raised to a minimum of 24 percent in order to provide statistical reliability and to make chicanery more difficult. Every other fleet fishing in US waters has 100 percent observer coverage.

The lack of provisions dealing with this driftnet fishery may become moot, however, if a preliminary injunction prohibiting its operation is upheld. In June, a coalition of environmental groups filed suit challenging the issuance of a marine mammal permit for the Japanese salmon driftnet fishery. A preliminary injunction was issued, and oral arguments are scheduled. If the coalition prevails, the salmon driftnet fishery would be illegal because it cannot operate without killing marine mammals, and it would not have a permit to take them.

—Dean Wilkinson



A fur seal is entangled in the webbing of a trawl net.

of the fish ensnared in the nets die and are never landed. Yet each year salmon and squid fleets from Japan, the Republic of Korea, and Taiwan deploy over a million miles of driftnets that nonselectively kill every creature which encounters them.

The provisions of the final law are not as strong as those in the original bills introduced by Congressman Charles Bennett (D-FL) and Senator Ted Stevens (R-AK). The statute, however, represents significant progress.

For the first time, the law will take steps toward regulating the squid driftnet fisheries outside of the US 200 mile zone. Although the data are so limited that it is impossible to make statistical projections, observer reports indicate that these fisheries may be wreaking havoc in the marine ecosystem. An average of two marine mammals were taken per observed set. There are an estimated 53,000 sets each year. In addition, the fleets may be harvesting salmon which otherwise would return to spawn in US waters. Within the last 18 months, federal agents have twice confiscated huge shipments of salmon which were being laundered

those countries for the monitoring and assessment of the impact of these fleets and for effective enforcement of regulations dealing with locations and seasons. A failure to enter into or implement such an agreement would be subject to certification under the Pelly amendment. The Pelly amendment provides that the President may limit or entirely embargo all fish imports from an offending country.

The law also requires the Secretary of Commerce to prepare an extensive report on the impact of driftnets within one year. The Secretary is also to look at a series of steps to alleviate the problem. Among the things to be evaluated are a net marking and identification system, the use of degradable net materials to reduce the impact of ghost nets, and a bounty system offering payment for the recovery of derelict nets. These recommendations are due within 18 months.

The law does not contain two important provisions, however. The original bills had a 60-mile driftnet free zone around the Aleutian Islands. Such a zone would markedly reduce seabird mortality and benefit marine mam-

Dean Wilkinson is the Wildlife Legislation Director for Greenpeace, USA.

## MARPOL Annex V ratified by US Senate

MARPOL Annex V, a part of the International Convention for the Prevention of Pollution from Ships (ICPPS) will, once it enters into force, prohibit ships from dumping their plastic refuse overboard and will provide more stringent controls on discharges of other kinds of garbage and trash. Recent ratification by the US Senate is expected to bring these requirements into force internationally.

But until nations carrying 50% or more of the world's shipping by tonnage have ratified, plastic and garbage continue to be thrown overboard because the treaty's criterion has not been officially met. The International Maritime Organization is currently engaged in recalculating the tonnage and is expected to announce its findings shortly.

# Dolphin kill worsens

Amendments to the Marine Mammal Protection Act in 1984 should have put an end to the import of tuna from nations killing dolphins at rates dramatically higher than the US tuna industry. Instead, though it has been documented that the Mexican tuna fleet is killing dolphins at a rate *four times* higher than the US fleet, no sanctions are in sight. The US Commerce Department has failed thus far to even define under what circumstances an embargo would be considered.

The result of the US government's refusal to confront the growing international tuna fleet operating in the Eastern Tropical Pacific is tragic news for dolphins. In addition to the 20,500 dolphins killed by the US fleet in 1986 it is estimated that foreign tuna seiners killed more than 100,000. Scientific papers presented at the 1987 meetings of the International Whaling Commission put the total annual estimated 'incidental kill' of dolphins at 150,000 and warned of severe depletion of several dolphin species. Dolphin mortality figures for 1987 are not yet complete, but even at levels considerably less than last year it is still by far the largest legally sanctioned killing of marine mammals in the world.

Dr. William Perrin, a scientist with the National Marine Fisheries Service and Chairman of the Cetacean Specialist Group of the International Union for the Conservation of Nature and Natural Resources, has indicated that "There is good reason for concern about this deteriorating situation." The International Whaling Commission has

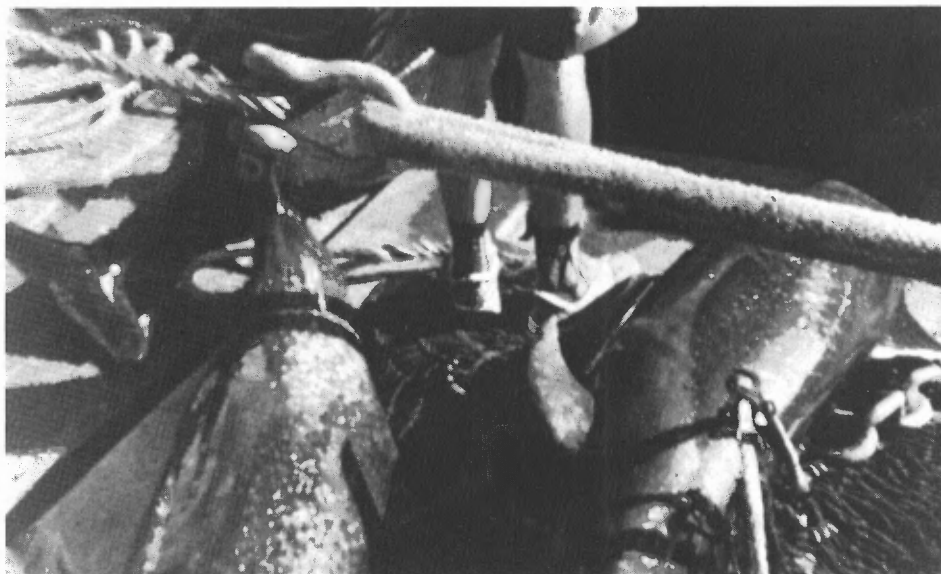

Dead spinner dolphins lie on deck of tuna vessels.

US National Marine Fisheries Service

repeatedly declined to regulate the kill of these small cetaceans, and the Inter American Tropical Tuna Commission (IATTC) does not set any international dolphin kill quotas. Perrin further notes that the eastern spinner dolphin population is estimated to have declined by 80% since purse seining began in the 1960s. This year another 2,700 eastern spinners were drowned by the US fleet alone.

Preparations are currently underway to challenge the US Commerce Department's negligence in this matter. The San Francisco law firm of Heller, Ehrman, White and McAuliffe has agreed to take the case on a *pro bono* basis. The goal is to force a US embargo on tuna imports from nations failing to bring their kill rates down, as required by the marine Mammal Protection Act. Earth Island Institute, The Whale Center, and the Marine Mammal Fund are coordinating the effort and all groups

and individuals are encouraged to participate.

On the domestic front, a campaign to boycott the products of Ralston-Purina will be announced at Ralston's annual shareholders meeting in St. Louis this month. Ralston-Purina, the parent company of Chicken of the Sea tuna, is the largest investor in the US tuna fleet and buys tuna from foreign vessels that are killing dolphins at horrendous rates. Ralston-Purina and H.J. Heinz are the two largest buyers and sellers of tuna in the world. Both companies have refused to restrict their purchases to tuna that is caught without killing dolphins.

—David Phillips

David Phillips is Co-Director of Earth Island Institute, headquartered in San Francisco, California. For more information about the campaign to stop the dolphin slaughter, write Save the Dolphins, Earth Island Institute, 300 Broadway, Suite 28, San Francisco, CA 94133.

## Fuller explanation of the IWC

We report below portions of a letter from Sidney Holt, longtime, distinguished member of the Scientific Committee of the International Whaling Commission, clarifying two errors in the Quarterly, Vol. 36, No. 3

There are a couple of points the Quarterly made about whales and the IWC which are not quite correct. One is in the box on page 3 where it says "If a majority finds against it, then the program must be dropped." If only that were true! In fact of course, the

proposing state has no compulsion to take any notice of the Commission's view, just as it has no compulsion to take notice of the Scientific Committee's view.

The second misleading statement (page 5) refers to "international observers appointed by the IWC". Unfortunately, the IWC does not appoint observers. Big efforts were made in the 1960s and again in the 1970s to get through the idea of proper international observers, and they failed

totally. All we have is a deal—negotiated under the IWC it is true—by which operators of "land stations" and pelagic operators are encouraged to negotiate with other member states with a view to appointment or exchange of observers.

—Sidney Holt



345

## Bird ring netted in undercover operation

An 18-month Fish and Wildlife 'sting' broke cover last October when across nine western and southern states 17 people (including a police officer) were arrested and 24 others charged with the sale of eagles, hawks, owls and other

Indian-style headdresses. Gallup, New Mexico, was the chief center for sales to dealers and collectors from Europe and the eastern US.

The charges stemmed from the killing of 600 birds but according to Fish

and Wildlife's chief enforcement officer, Clark Bavin, this number represents only a tiny fraction of the "tens of thousands" of protected animals taken annually by poachers. While there is no estimate of the total traffic in poached wildlife, some Administration officials believe it runs second only in value to the traffic in drugs.

US Fish and Wildlife

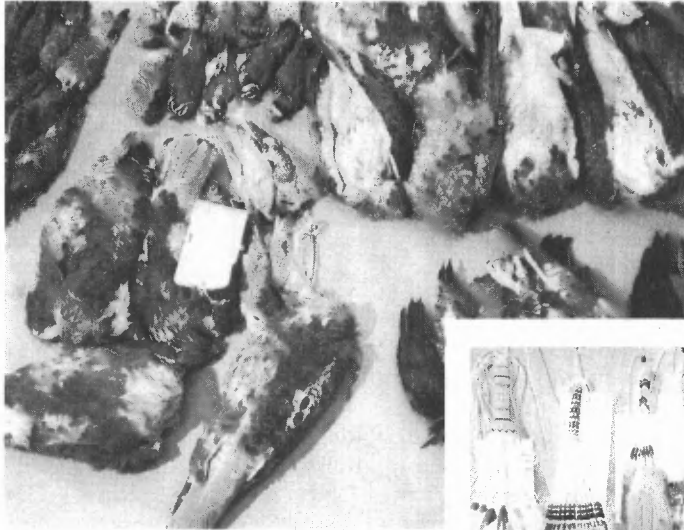

Rare birds killed to make headdresses for sale to tourists

protected birds. Seven of those arrested have entered into plea agreements and await sentencing. The maximum penalty carries a two year jail sentence and a \$250,000 fine.

The birds were stuffed for mounting and some of their feathers used for



US Fish and Wildlife

## Smuggler gets two years in jail

After denying countless endangered birds their freedom, Gregory Jones has finally lost his. At least for a while. Jones, the owner of Bird World in Louisiana, has been sentenced to two years in prison for smuggling over 300 Yellow-naped Amazon parrots (including 90 babies). In addition, he must pay a fine of \$140,000. Also convicted were five others, including Jones' son, who faces a ninety day jail term.

Many of the parrots, which are protected by CITES, were stuffed in the side panels of a car while being smuggled into the US from Mexico. They were then sold for up to \$1,000 each.

Though the charges stemmed from an investigation started in January of last year, Jones had been suspected of such activity for quite a while. In addition to Bird World, which imported tropical birds, Jones operated several USDA quarantine stations in Miami. To guard against the spread of Newcastle Disease (which can wipe out poultry populations) birds are supposed to be quarantined before being allowed entry into the US.

Of course, birds smuggled by Jones never made it to one of his quarantine stations. And many were carrying Newcastle's so they, along with the birds they infected, had to be destroyed.

According to the *Los Angeles Times*:

Jones is one of the largest pet-bird distributors and one of the principal importers of yellow-naped Amazon parrots, the species involved in this case, said Assistant US Attorney, Charles Crandall, who prosecuted the case.

In November, both men had  
*continued on next page*

## Pretty Polly's ugly smugglers

An estimated 25,000 parrots are smuggled into Texas from Mexico every year. Seizures and arrests, though quite common, are negligible when set against the volume of traffic. Border patrols are too busy trying to stop the influx of drugs to pay much attention to 'mere' bird smugglers.

Parrot smuggling, though, is a major business. According to Fish and Wildlife agent, Joe Ramos, it "even involves organized crime". Mexican yellow-headed parrots, which are nearly impossible to breed in captivity may cost just \$75 each in Mexico but the price can soar to \$450 in the US border towns (comparable prices for red-headed parrots are \$50 and \$150) and still more, a lot more, further north.

The parrots are snatched from their nests as very young fledglings and must be hand-fed to have any chance of sur-

viving. Inevitably a great many die. Plainly the annual depredation on parrot populations runs way in excess of the 25,000 quoted earlier, for that is simply the estimated number surviving the long and traumatic journey from the sanctuary of the nest to the alien world on the northern side of the Rio Grande.

Smugglers do not exist in a vacuum. They require dealers to market their illegal exports.

Ramos says that US visitors to Mexico often become involved in parrot smuggling. They make contact with a parrot seller, establishing a distribution point in their home town and then 'innocently' advertise the stolen birds in the local press. That seemingly harmless hometown newspaper ad may be featuring smuggled, traumatized and, perhaps, diseased birds.



## Stolen, trailed and recovered

Spix's macaw clings to existence by the tips of its claws. Just four wild specimens are known to survive in its one and only habitat in northeastern Brazil. In 1985 just two young were born. Both were stolen.

The CITES Secretariat and the TRAFFIC Directors in the US and South America were alerted and the search for the missing fledglings was on. The trail led to a large house in Asuncion, the capitol of Paraguay.

The Paraguayan authorities were informed and proved most cooperative. At noon on 25 March last, with police support, Paraguay's Director of National Parks and Wildlife, Hilario Moreno, and the Director of TRAFFIC (South America), Juan Villalba-Macias, began their search of the suspect house.

While this was happening Villalba-Macias noticed the rapid closing of a door on the second floor. He ran to the room, broke in and found a servant holding a traveling bag. Inside the bag were the birds, alive and well—discovered in the nick of time as they were about to be spirited away.

Less than 24 hours later the two tiny birds with the giant illicit trade value of \$20,000 each were on a plane to Brazil en route to Sao Paulo Zoo. Spix's macaw had taken a small but desperately needed step back from the brink of extinction.

### Smuggler, *continued from page 8*

entered guilty pleas in connection with the case. Gregory Jones pleaded guilty to two felony counts of receiving protected wildlife and making false statements to a federal officer; his son pleaded guilty to a single misdemeanor arising from the scheme.

The guilty pleas are the latest developments in a criminal prosecution arising from an extensive investigation of an exotic bird-smuggling ring that operated along the US-Mexico border. The ring is suspected of having brought thousands of birds into the United States from Mexico in recent years, prosecutors say.



## Jaguar's revenge

Arthur William Smith was sentenced to three years imprisonment and ordered to pay \$10,000 in fines for violations of the Endangered Species Act, the Lacey Act, and firearms violations. Smith, an organizer of hunting parties, was charged with possession of a bald eagle and aiding and abetting the killing and transportation of an Alaskan brown bear, among other endangered animals.

Under a plea agreement Smith has admitted to some of the charges, including that of importing a jaguar pelt from the Central American country of Belize. He claims to have slain the jaguar himself with a machete because it was menacing him or some cattle. But the truth or otherwise of this claim has no bearing on the charges of importing the pelt and then transporting it across state boundaries. This isn't Smith's first brush with the law. In 1975 he was convicted of Grand Larceny and in 1980, of firearms violations.

## Ducks limited—more and more so

A waterfowl symposium in Memphis was treated to some disturbing revelations by two reformed poachers. "Poaching's a way of life," said one. "You grow up killing as many birds as you can. You laugh at regulations. You think they are silly when you see so many birds."

"Poachers just don't believe that what they are doing can be wrong," said the other. "Why, I used to take half a case of shells and stay in there all day and kill 'em."

A wildfowl conservationist spoke of baiting and poaching being far more common than most people imagine.

## Lacey Act Regulations Under Fire

*continued from page 1*

poning the effective date for six more months. The Animal Welfare Institute and eleven other animal protective organizations have gone to court to enjoin the Interior Department from this abrupt reversal.

The law suit, filed 1 March 1988 by Ray Bolze and Margaret Fitzsimmons of the law firm of Howrey and Simon acting *pro bono* for the plaintiffs, also "seeks a declaratory judgment that postponement of the final rule on 10 February was ineffective and contrary to law, and that the 10 November 1987 final rule is in effect." It states, "The animals continue to die or sustain horrible injuries from overcrowded shipping crates, from lack of water and food, and from changes in temperature and pressure in airplane cargo holds. With the approach of the 8 February 1988 effective date of the rule on humane transport, traders dramatically stepped up their import activities so as to clear birds before that date. At Miami Airport, authorities report that in January and early February, 1988, birds arrived in greatly increased numbers, crammed into small, overcrowded crates, to avoid the impact of the new Rule. These inhumane practices will continue unabated until the Rule on Humane and Healthful Transport of Wild Mammals and Birds is made effective."

The judicial decision is eagerly anticipated by all concerned.

"I can go up in a plane and find a hundred baited spots in a single day," he said. He believes that more waterfowl are being slaughtered illegally than legally. He also believes that even if the major cause of declining duck populations is the loss of nesting grounds in Canada and the northern US, poaching is a significant contributor.

In the view of the two ex-poachers the changing of attitudes will prove an uphill task. "Now that I've cleaned up my act, my buddies won't hunt with me any more," bemoaned one of them. The other nodded sadly.

# SETTING THE RECORD STRAIGHT

The journal, *Science*, declined to publish a letter to the editor correcting some of the errors in a two-page illustrated article. *Science* indicated lack of space as the reason for rejecting the letter. So that the misinformation does not stand unchallenged, the letter and a group of photographs from the report in question are printed below.

These photographs were submitted to the National Institutes of Health 14 October 1987 with a report, prepared by Cathy Liss and Louise Wright, documenting long-standing conditions at a cancer laboratory in Baylor College of Medicine. Captions include quotations from the Baylor staff member who submitted the photographs.\*

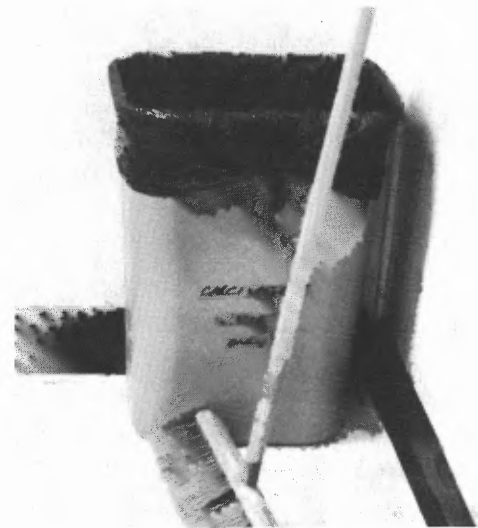

Open trash can for carcinogenic materials. "The conditions are bad not only for the rodents, but for the people who have to work there, too."



Unrepaired roof. "The roof has been a problem for a long time. There is water dripping through the roof. This has been mended numerous times, but not well enough, and the problems returned."



**ANIMAL WELFARE INSTITUTE**

P.O. Box 3650 Washington, D.C. 20007

November 29, 1987

The Editor  
*Science*  
1333 H Street, N.W.  
Washington, D.C. 20005

To the Editor:

"Animal Regulations: So Far So Good", by Constance Holden (13 November, p. 880-882) states that NIH's Charles McCarthy "relates that after one prominent scientist published some editorials criticizing animal rightsters, his office received a batch of materials containing photographs and allegations of noncompliance at the scientist's institution." Although the Animal Welfare Institute and the Society for Animal Protective Legislation which I represent as a full-time volunteer are not animal rights organizations it is painfully apparent that this anecdote refers to us.

The "batch of material" is our carefully prepared 23-page summary illustrated with 33 color photographs showing filthy, hazardous conditions with carcinogenic materials at a laboratory using thousands of mice and rats at Baylor College of Medicine.

Until we read Constance Holden's article, we thought we had been helpful to NIH by providing documented information enabling the agency to carry out its duties in enforcing the Health Research Extension Act of 1985 and in ensuring that government funds spent on research are dispensed in a manner that can be expected to result in accurate scientific information. If as reported, hoods over cages containing carcinogens are not washed between experiments, the animals were exposed to unintended carcinogenic cocktails. This is just one example of the information we provided to NIH's Office of Protection from Research Risks (OPRR) which Dr. McCarthy heads.

When we delivered our report to the OPRR we were praised by NIH staff and encouraged for having brought the fully documented evidence of non-compliance with NIH requirements directly to NIH rather than going to the press with it. But now that Dr. McCarthy has seen fit to do just that it is necessary to present the facts.

The "prominent scientist" (Dr. Michael DeBakey, Chancellor of Baylor College of Medicine) made personal allegations about me, as inaccurate as they were insulting, in a *Wall Street Journal* editorial (16 June 1987) to which I replied (13 July 1987) and *The Scientist* reported on this (21 September 1987). A Baylor staff member, who had been trying in vain for years to get the cancer research laboratory, referred to above, cleaned up, repaired, and decently managed for the sake of both the laboratory workers and the mice and rats, happened to read *The Scientist* article and phoned me, asking for help. This was no casual complaint; it was documented by more than one hundred photographs and color slides showing such things as uncovered pails over-

\*The photographs were taken over a nine-year period by a number of different people concerned about the bad conditions. Most are recent, taken within the past four months.



Open pail of dead mice under refrigeration.

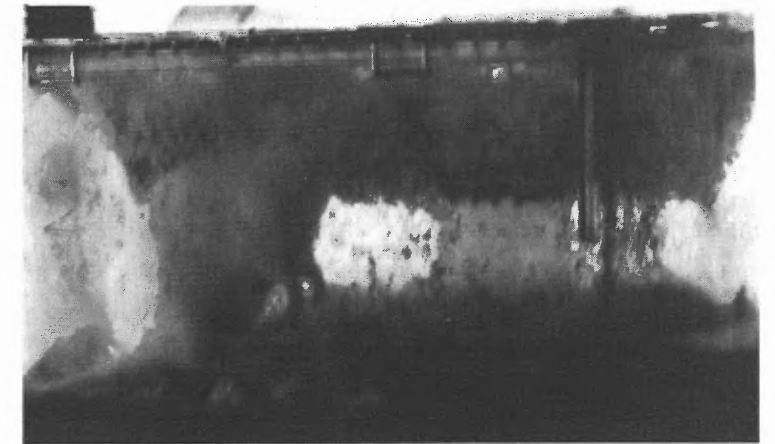

Plastic cages encrusted with dirt. "Animals are in deep feces."

flowing with dead mice under refrigeration, an open trash can for carcinogenic materials, plastic cages encrusted with dirt so thick that the animals inside were barely visible, most weirdly, a mummified mouse, overlooked in one of the sand boxes used to steady the weighing table, huge unrepaired holes in the ceilings, and with the pictures, descriptions of procedures completely at variance with requirements set by NIH for grantees. In 1986 Baylor's College of Medicine received more than \$37 million in NIH grants.

OPRR sent our report to Baylor, and the long-sought changes immediately started to occur. We understand that nearly all the animals have now been moved out of the hopelessly dilapidated building and put under proper care. We are delighted that this reform has finally taken place.

According to the Holden article, Dr. Neal Miller claims that "even previously moderate animal organizations are getting more radical."

Because the organizations I represent have consistently held the same moderate policies for more than thirty years, maintaining strict standards of discretion, and offering scientists and administrators practical advice on animal welfare through our books and other presentations, it is ironic that I should have been singled out for attack by the Chancellor of Baylor's College of Medicine and doubly ironic that this very attack should have directly led to our receiving the overwhelming documentation of these disgusting conditions at a laboratory in his college.

In the paragraph immediately following Dr. McCarthy's version of these events, Dr. Frederick King of Yerkes Primate Center is quoted on "infiltration of activists," "illegal activities" and "offers to purchase information." This is an unfortunate juxtaposition. Any implication that we engage in such actions is completely false. We were appealed to as a last resort by a distressed staff member.

The statement that "inspectors are only required to list negative criticisms" also needs correction. As one who has read large numbers of Veterinary Service's inspection reports under the Freedom of Information Act, I know that it is routine for the inspectors to write "deficiencies corrected" with the date of inspection when this is the case.

The Holden article is heavily slanted against the US Department of Agriculture, Animal and Plant Health Inspection Service (APHIS) throughout, which is not surprising given the sources consulted. APHIS Veterinary Services is, of course, criticized by those who resent having to adhere to the minimum standards of the federal Animal Welfare Act, but it deserves great credit for having done an immense amount of good, in its moderate and careful way, to rid scientific institutions of the abuses that still severely mar the practice of animal experimentation. If mice and rats were included in the coverage of the APHIS regulations, it is unlikely that I should have had to write this letter concerning the Baylor facility, for the USDA inspectors would have written up the failure to adhere to standards and persisted until they were able to write "deficiencies corrected."

Sincerely,

*Christine Stearns*



Weighing table set in sand boxes where long dead desiccated mouse lay unobserved. Close-up appears below.

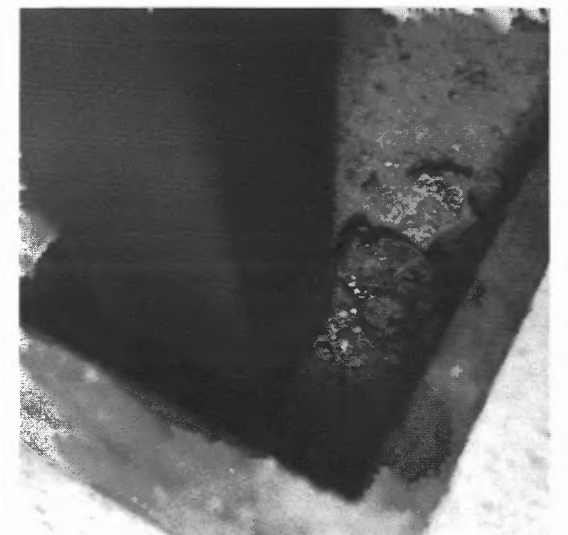

# BARBARISM IN THE FOOD MARKET

In many of the market places of Hong Kong, endangered species such as leopards and tigers can be yours for the asking. Last March, *Asiaweek* devoted most of its issue to the story of these animals as they make their way to the plates of those with exotic palates.

According to *Asiaweek*, "the pipeline in wildlife trade stretches all the way to China's borders with Burma and Vietnam. A dealer in Canton told of a tiger that was secretly transported from Burma to Guangxi, where it was kept caged in a farmer's house. The selling price: about \$1,280."

Even taxis are used to transport the animals. Reporter Michael Wong rode in one with a wildlife dealer who said that he "can arrange to send live tigers or leopards up to Sheung Shui [in Hong Kong's New Territories] and you can pick up your goods there. It's hard to send bears across the border, but as for tigers or leopards, it's easy."



S.C. Tam/Asiaweek

Long-tailed Macaque in Quingping Market, Canton, February 1987. Range: Southeast Asia. World status: vulnerable. Protected. Subsequently killed and eaten.— (*Asiaweek*)

## Weak enforcement mocks strong laws

What has Hong Kong done to protect its endangered species? As a member of CITES (Convention on International Trade in Endangered Species), Hong Kong has strict laws on the books prohibiting the importation and sale of endangered animals. Nevertheless, demand for exotic food continues to be met because enforcement is weak.

Five inspectors are employed to

see that local markets and restaurants do not offer endangered species but in 1987, only 80 inspections were made resulting in 14 seizures. Among the items seized: 12 bear paws—smuggled, in all likelihood, from the US.

Hong Kong is considering strengthening their laws and just recently banned the sale of rhino horn (see story at right).

## Some cause for cheer

In the British House of Commons on 25 January the Prime Minister was asked what the government was doing to "clamp down on the internal and external trade in black rhino horn products in Hong Kong." Mrs. Thatcher replied that Hong Kong had banned the export of all such products since April 1986 and that a "total ban on the sale of rhino horn products within Hong Kong will take effect from July."

# Men, monkeys and agony

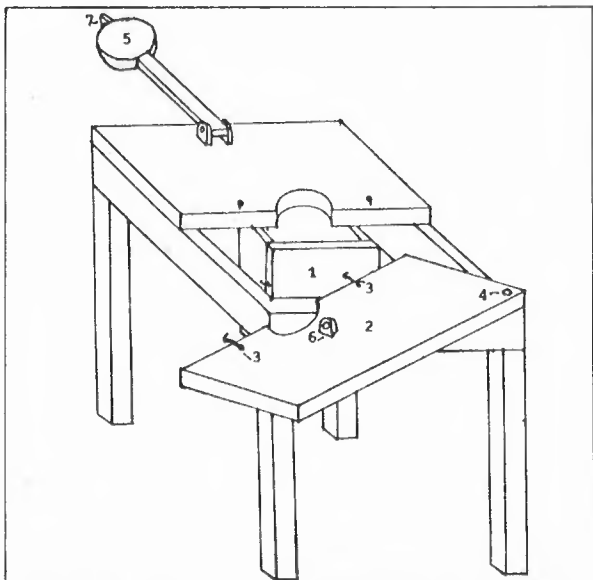

Table for scalping the monkey to expose its brains.

The practice of eating monkey brains is still going on. Feasting on this delicacy requires special implements. A specially designed table with a wooden box at the bottom is used. Half of this table top is pivoted to allow movement. The monkey would be forced into the wooden box which is small to restrict movement. The head is allowed to protrude through the hole at the center of the table.

The lid to the box is then latched. After this, the pivoted table top is drawn shut. A metal bowl at one end of the pivoted arm fixed to the table is fitted directly onto the monkey's head and latched into place leaving the portion above the ears exposed.

A sharp scaler is used to cut round the skull vault. By then the palpitating brain is exposed and brandy is poured into the exposed area of the brain. A spoon is used to scoop up the brain matter, or a straw is used. Monkey's brain is taken as an aphrodisiac.

— Excerpted from an article in Suara Sam, published by Friends of the Earth, Malaysia

## China Imprisons 26 for Killing Pandas

From Reuters

HONG KONG—Twenty-six men have been sent to prison for killing and skinning giant pandas in China's southwestern Sichuan province, the China News Service said.

The sentences ranged from three years to life. The agency said on Wednesday that the men killed six pandas, a protected species in China, and tried to smuggle their skins abroad for sale. They also skinned 16 pandas that had starved to death because of a shortage of the pandas' staple food, arrow bamboo.

About 1,000 pandas are believed to exist in the wild, but their numbers are dwindling. China this year warned that poachers and smugglers could face execution.

Reprinted with permission of Reuters



Puppies for sale in food market Kuala Lumpur, Malaysia.

Domesticated pets like dogs and cats are not spared from the cooking pots. Dogs, usually puppies of about six months old, are killed by tying the animal which is then hung by its hind legs. Boiling water is then poured over it until it dies. This method is believed to cause the blood to rush upward to the head leaving the flesh tender. Cats are placed into gunny sacks and drowned in tubs of water, or killed by scalding.

— From Suara Sam

## Rhino killings continue across two continents

Last November a large gang of poachers from Zambia entered Zimbabwe's Mona Pool national park and killed at least 13 black rhinos. The killings brought the 1987 toll to 105, reducing the park's population of this highly endangered species to under 600.

In Assam, northern India, the Kaziranga national park, main home of the one-horned rhino, has also been

invaded time and again by poaching gangs. During the past six years about 180 rhinos have been butchered.

The poachers there know that rhino horn commands exorbitant prices in illegal channels. They also know that the Kaziranga national park contains about 85% of the world's dwindling population of one-horned rhino, now down to approximately 1500.



Viki Posoff

3511

# "A TALE OF TWO CITIES"

When the City of Los Angeles opened the first municipal low-cost spay and neuter clinic in 1971, it seemed a most unlikely place to attempt a turn-around in animal control. With a human population of some three million and an estimated animal population of a million dogs and cats, it covers the largest area of any city in the world. The results in the following sixteen years have attracted interest from every major municipality in the United States as well as Canada and many foreign countries.

Unfortunately most efforts to duplicate the successes of Los Angeles have been hampered by the badgering of veterinarians. Yet a notable exception is the Vancouver British Columbia S.P.C.A. clinic opened in 1976 and spearheaded by director C. James Homes and a retired (and enlightened) veterinarian, Dr. Colin Collin. The two, each dedicated to eliminating the constant destruction of surplus animals, set about to establish new records in performance. Ten thousand surgeries were performed in the first ten months, and to date, more than 125,000 spays and neuters have been accomplished. Even more remarkable is the fact that pregnant animals are not excluded with several hundred fetuses aborted monthly. This seldom used procedure accounts for a large number of additional animals. Said Michael H. Weeks, executive director following the recent retirement of C. Jack Homes, "We may be approaching the point in most areas where the only dogs we are putting down are truly unadoptable. Cats remain another matter."

Both Los Angeles and Vancouver directors credit much of their success to the support of municipal officials, dedicated volunteers, and an enthusiastic public. Robert Rush, General Manager of Los Angeles Department of Animal Regulation, said in an address to the Dallas City Council in 1976 that he could count on the fingers of one hand the criticisms he had received on the clinics. Today, it might take ten fingers, but complaints remain exceedingly rare.

Despite spiraling inflation, the Los Angeles City Council voted to hold the line on \$17.50 spays and \$11.50 neuters until 1984 when fees rose to \$20 and \$17. Still included are basic canine and feline shots, overnight and emergency care, no restrictions on size, and a mortality rate of less than one in a thousand.

Los Angeles would be overwhelmed today with animals and related prob-

lems had the estimated increases gone unchecked. Mayor Tom Bradley, one of California's most admired and respected politicians, got where he is by pledging allegiance to the balanced budget and winning the support of the business community. In short, he has no patience with fly-by-night projects. The mayor has steadfastly supported the clinics and their role in a city beset by problems of growth, smog, homeless people, crime, and more passenger autos on the streets (about five million) than any other metropolitan area on Earth. No doubt he finds the success of the clinics, both in popularity and reduction of animal problems, an administrative joy.

An important by-product of the Los Angeles and Vancouver clinics is the wealth of information resulting from well-maintained records. In a field where long range planning is "tomorrow" and statistics are haphazardly kept, if at all, the figures of their efforts are invaluable in planning effective animal control. The charts shown here are examples of the information available for analysis.

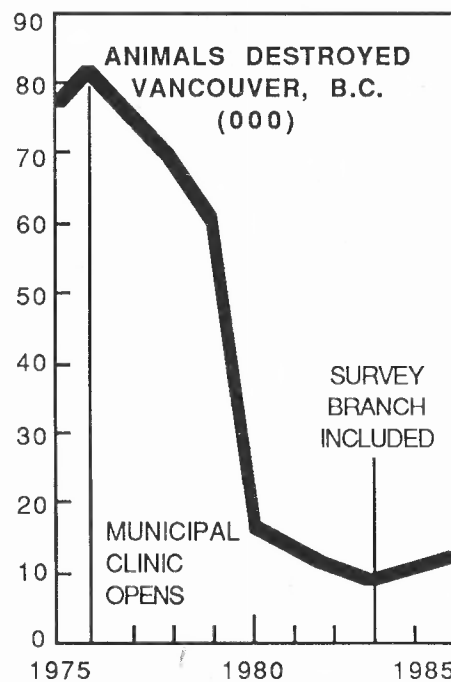
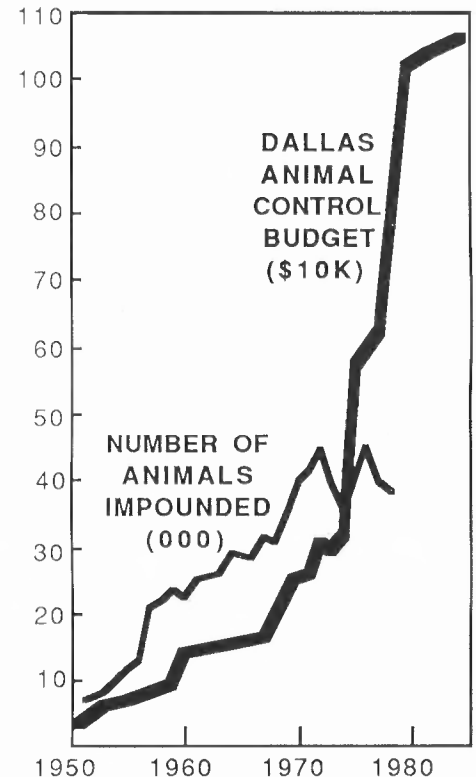

With such role models why haven't clinics opened throughout the country? The public is ready and willing, but efforts have been impeded by vested interests. "Government intrusion, free enterprise, socialization of animal medicine, and federal funding" are pious phrases in the anti-clinic arguments.

It is argued: "Not everyone owns pets; why should their tax money go to neutering other people's pets?" Yet, the Los Angeles City Clinic had been open only two years when *Modern Veterinary Medicine*, March 1973, reported: "It is clearly evident from the financial records of the spay clinic that a city-run spay program need *not* be a burden on the taxpayers, and this makes it very attractive to other cities with animal over-population problems."

Economically, veterinarians have prospered in private practice with the advent of the municipal Los Angeles clinics. Some 20,000 animals were

1352

altered yearly in private practice before the clinics opened. Three years later, the number had risen to 50,000!

Dyer Huston of the Los Angeles Department of Animal Regulation, says veterinarian opposition has lessened, and some veterinarians voice appreciation for the clinics' work. As impoundments have decreased, the city department has emphasized adoptions and cruelty investigations: 72% of the 104,674 animals impounded in 1976-77 were destroyed. Ten years later, only 58.01% of the 104,357 impounded animals were euthanized.

Vancouver reports similar results. Veterinarians there have opened clinics with comparable fees. As the SPCA clinic's load is lightened greater concentration is available for adoption and

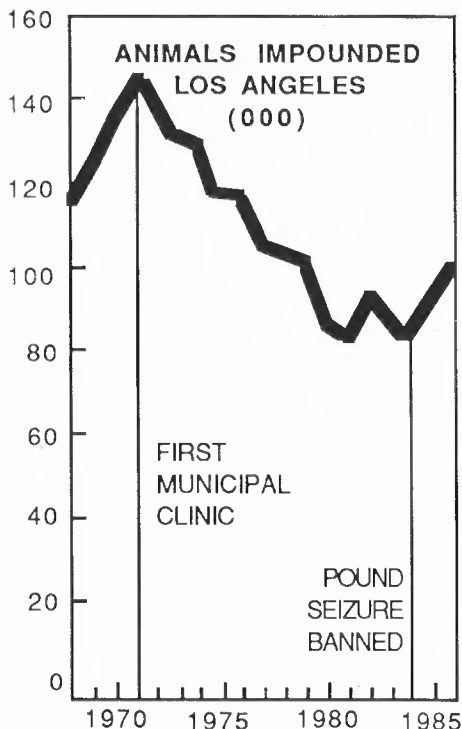

humane education and to treat ownerless, injured animals. "Not to kill any animal suitable for adoption" was listed as the number one goal in the Vancouver 1984 annual report. From 80,000 destroyed animals to 9,000 in 11 years makes that goal a distinct possibility.

Stronger leash laws, reduced license fees for spayed females, and more responsible pet ownership are important, but the basic key to solving the problem lies in reducing surplus numbers. This is best accomplished by the mass production of sterilizations in clinics devoted solely to that purpose. Spaying and neutering the owned pet turns off the faucet. Otherwise, de-

### Ten-Year Savings from Low-Cost Clinics to Los Angeles Taxpayers

Animal impoundments before 1971 increased at a rate of 15%. This growth increase is shown in Table I. Table II gives the actual decline following establishment of the clinics. With impoundments costing \$24 each to the taxpayers, the savings for these ten years were: \$28,158,240

	Table I (15% increase)	Table II (actual decline)	
			2,303,435
1971	144,530	144,530	-1,130,175
1972	158,983	132,254	1,173,260
1973	174,881	127,554	x \$24
1974	192,369	118,964	\$28,158,240
1975	211,606	117,280	
1976	232,767	114,363	
1977	256,044	104,674	
1978	281,648	99,753	
1979	309,813	88,284	
1980	340,794	82,519	
TOTAL	2,303,435	1,130,175	

Eighty thousand animals were destroyed in Vancouver in 1976, and the pet population was increasing at a rate of 10% per year. Had this increase been permitted to continue for just six years, the numbers of animals destroyed would have approximated 750,973.

stroying continuous litters is comparable to bailing out the sink with the water running.

—Virginia Prejean

Virginia Prejean is founder of Animal Advocates and has long worked to promote spay/neuter programs.

## From lions to mice: fertility control

Pioneering in a field long neglected by wildlife managers, two professors, Priscilla Cohn, a philosopher, and Ulysses Seal, Chairman of the Captive Breeding Specialist Group, Survival Service Commission, International Union for the Conservation of Nature, brought together twenty birth control experts for a two-day symposium in Philadelphia this November. Attendance was such that the first session had standing room only as participants viewed films showing prides of lions in Etosha where implants of fertility inhibitors in lionesses has kept the population stable and reduced deaths of cubs in the Southwest African park. At the other end of the scale, birth control methods effective on mice were discussed by scientists primarily concerned with providing the best contraception for human patients.

The first speaker was Dr. Jay Kirkpatrick, who reviewed the history of animal birth control and made clear its importance. Dr. Kirkpatrick said: "Chemical fertility control can bring

long-term economic benefits, since well-planned wildlife management programs will prevent unnecessarily large population increases by attacking the heart of the problem—reproduction. Hunting, capture and sale, trapping and poisoning really only address the symptoms of overpopulation, not the causes. It is the difference between prevention and cure."

The data supplied by the scientists shows that the technology is now at hand for developing non-lethal methods of controlling wildlife populations. Since these methods are applicable to all mammals, they could also provide an inexpensive, less invasive means of controlling the burgeoning pet population, controlling predatory species (coyotes), as well as skunks and raccoons to prevent the spread of communicable and contagious disease.

The papers are currently being edited for publication. For further information, write to Professor Priscilla Cohn, PNC, 1518 Willowbrook Lane, Villanova, Pennsylvania 19085.

353



## What lies ahead for the kangaroo

Last September the European Parliament voted by a hefty majority for a Resolution requiring the European Commission to look into Australia's kill of kangaroos with a view to determining whether its size and methods warranted a ban on European imports of kangaroo products.

Such a ban would virtually kill off the kangaroo trade. Europe is the market for 90% of Australia's export of raw kangaroo skin. However, it will not be easily achieved because certain countries within the European Community, notably Italy which is the chief importer of kangaroo skin, are believed to be opposed.

Meanwhile the Australian government, in its attempts to give a scientific gloss to what is in reality a commercial enterprise has been embarrassed again by the state of Queensland. The state has requested a 1988 quota of 2.24 million kangaroos, well in excess of its 1987 quota. The request comes quite unsupported by any scientific back-up or even the outlines of a management program.

Conscious of the appalling publicity aroused by Queensland's cavalier disregard in recent times of the constraints that normally govern this kind of exercise, the Australian government has remained mute. Traditionally the next year's quotas are announced well before the end of the previous years. At the time of this writing, mid-March, the 1988 quotas have still to be announced.

A bill to ban all imports of kangaroo products into the US has 119 co-sponsors in the House of Representatives. Hearings are expected later this year.

## Please help stop the trade in frogs' legs

Belatedly realizing that frogs, those hungry devourers of insect pests, render an invaluable ecological service—and one, furthermore, that comes free of charge unlike those pestilential pesticides which are needed to replace them—the Indian government banned the export of frogs' legs. This happened last spring and was reported in the 1987 spring/summer issue of the *Quarterly*.

But with India, formerly the world's biggest exporter of frogs' legs, now out of the market, other countries, notably Bangladesh and Indonesia are striving to fill the gap. The issue is not just an ecological one. The method by which the frogs are killed—slicing their torsos in two and then tossing them into a heap to die slowly—would seem calculated to cause maximum suffering to the animals.

We are therefore listing some of the principal importers of frogs' legs into this country and we urge you to write to as many of them as you can, urging them to end these imports.

### Importers of Frogs Legs (US)

Amendif & Schultz Inc  
1017 Fremont, Box 788  
South Pasadena, CA 91030

Arne Paterson International Inc.  
P.O. Box 820, Roger Street  
Gloucester, MA 01930

B.A. Bosshart Food Brokerage Co.  
5912 West 35th Street, Suite B  
Minneapolis, MN 55416

Th. B. Sessier Co., Inc.  
70 Pine Street  
New York, NY 10270

Badger Produce Co., Inc.  
2321 Mustang Way  
Madison, WI 53704

Baker Sales Company  
2312 Parklands Road  
Minneapolis, MN 55416

Donlan Fish Corporation  
3116 Corunna Road  
P.O. Box 304  
Flint, MI 48501

E.C. Sweeney & Co.  
1098 S. Milwaukee Avenue  
Wheeling, IL 60015

Edward Feign Enterprises  
P.O. Box 686  
Aptos, CA 95003

Empress International Ltd.  
3000 Marcus Avenue  
Lake Success, NY 11042

Fisher Bros. Fisheries, Inc.  
P.O. Box 965  
Green Bay, WI 54306

Kent Trading Corporation  
P.O. Box 69-3309  
Miami, FL 33169

## Timber traders will fund conservation

Contrary to the more pessimistic predictions, the rainforests of the world did gain something from the meeting in Japan last November of the Parties to the International Timber Trade Organization. This fledgling organization, which consists of most of the prime producers and consumers of timber, committed itself to funding 16 projects, 12 of them conservation projects.

Perhaps the most significant of these was the decision to place under "sustainable management" 100,000 hectares of rainforest in the state of Acre, western Brazil. If carried through as intended and agreed, this project will ensure not only that logging abides by the tenets of conservation but also that the lifestyle of the Amerindian tribespeople there is not seriously disrupted. It is a project that will need close watching.

## RAINFOREST VICTORY—BURGER KING BOWS OUT

*Rainforest Action Network* notched up a significant triumph when Burger King, the hamburger chain, bowed to pressure and promised to stop importing beef from Central America. The consumer boycott organized by the Network had paid off, demonstrating the value of concerted grassroots action.

The importance of this victory can be gauged from the fact that hitherto Burger King has been purchasing 70% of Costa Rica's beef exports, amounting to some 16,000 tons annually.

## Black-footed ferret births in captivity

There is cause for celebration in Meeteetse, Wyoming. For the first time ever, black-footed ferrets are breeding successfully in captivity. Seven babies are now eight months old and Tom Thorne, their veterinarian "couldn't be more delighted. We continue to be nervous but I would say I'm guardedly optimistic."

Two years ago, optimism was in short supply. Few ferrets remained when an outbreak of the sylvatic plague nearly wiped out their prey, the prairie dog. And many who survived *that* disaster succumbed later to distemper. By the end of 1985 only six black-footed ferrets were known to survive in the wild (see *AWI Quarterly*, winter 85). Little hope remained for the species when these six were taken to start a captive breeding program.

A previous attempt in the late 70's to breed these rare animals produced a litter but none survived. Inbreeding may have been the cause. "We have the advantage of their experience but we are still treading on new ground," says Thorne. "If we get through next year with a pretty good birth rate and get the



*Two month old captive born ferrets*

colony split, then we have a good chance of succeeding."

Still, there is concern the ferrets are not being split into separate colonies fast enough. Tim Clark is a biologist who works with Wyoming Game and Fish to find suitable areas for the ferrets once they are reintroduced to the wild.

He worries that the world's population of black-footed ferrets are housed in one facility. "If there's lots of reproduction it won't be an issue; they'll have to subdivide." But until then, fingers are still crossed for this endangered mammal.

—Jessie Despard

## LETTERS: Private wildlife haven befouled by cruel trapping

Dear Sirs:

My husband found a beautiful pine martin on our property, dragging itself away from a leg hold trap, leaving a portion of its limb in the trap and a bloody trail in the snow. One of its legs was missing a paw, the back leg missing at the hip joint, the third leg a mangled mess of torn skin and crushed bone. My husband had pity on the poor animal and ended its misery by shooting it.

We worked hard to buy this 100 acres, because we like living in the woods and wanted to keep our property as a small game reserve. Our property has been posted time and again; just two weeks before this incident, we put up new signs. These were promptly torn down, as usual. A storage building that was on our property has been vandalized so many times, during trapping season, that we are no longer repairing it, and in fact we are going to burn it down.

Both my husband and I work so that we can pay our taxes. We don't have time to constantly police our property.

What are we supposed to do? We spend money on signs that are torn down. We give verbal warnings and receive verbal abuse and threats in return. My husband talked to the local game warden who says that our taxes don't pay his salary, but that trapping licenses do. He refused to get involved. As a matter of fact, he advised us that it would be best not to get too tough with trappers because they might come and set unmarked snares and traps all around our house, and *we* might come to harm. By the way, our property is in Minnesota, not on the edge of the frontier. I had understood that civilization had reached here some time ago.

My husband and I wanted our property to be a safe haven for animals, because we enjoy the wild, *living* creatures around us. We had a family of otters living in our pond. We used to enjoy watching them play on summer evenings. Because my husband and I both work, we weren't here to watch when the traps were set. But we found the evidence of their deaths, all four of them.

Four minus four equals zero. This is subtraction not multiplication—not a renewable resource after all. Once again, this was done on our property where the signs had been torn down. Some heroes we have here.

The irony of this situation is this: my husband freely admits that he shot this pine martin to end its suffering. By admitting this, he will probably be jailed, because he doesn't have a trapping license. He'll lose his job, and won't be paying taxes. But the silver lining is, then we can go on public assistance and then we will have time to patrol our property.

In all, this is a sorry, but true, tale of two people who just wanted to live in peace and harmony with nature on the property that they bought and paid for. It's also a story of those truly heroic northwoods trappers, who let nothing stand in the way of their frenzy to mutilate another live animal. Sign us truly disgusted in northern Minnesota,

Timothy and Maxine Hughes

3551



# HUMPBACK WHALES AS INDIVIDUALS

In the mid-1970s, researchers led by Steve Katona of the College of the Atlantic (COA), showed that individual humpback whales, *Megaptera novaengliae*, could be identified over a number of years from photographs of markings on the ventral side of the tail flukes. Since then, Katona and his colleagues have coordinated and curated an extensive catalog of fluke photographs of over 3,600 individual whales.



The NMML computer system is simple. Researchers select a pattern type that most closely resembles the pattern in the photograph, and then enter the location of various marks and scars based on the Balcomb/Katona fluke sector map. This information is stored in the data base. When a match of an unknown whale is requested, a fluke matching algorithm (developed by McGill Lynde of OceanTech, Inc., Seattle, WA) compares each photograph in the data base to the unknown. The computer automatically displays the photos on the video screen in likely order of match. A researcher can scan hundreds of sorted photographs in just a few minutes.

As the number of identified whales grew, it began to take more and more time to match new photographs to those already in their collection. COA workers estimate that they spend well over an hour matching each new photograph. In the late 1970s, Ken Balcomb and Katona tried to speed the matching process with a computer sorting program linked to a video disc, but their efforts were limited by the computer technology of the day.

Meanwhile, researchers were collecting photographs in different regions of the North Pacific. Individually each had developed a catalog, containing about 150-1,400 different whales, but there had been no comprehensive catalog that

synthesized all the North Pacific collections. So the National Marine Mammal Laboratory (NMML) began developing a new computer system which was loosely based on the Balcomb/Katona model, though more advanced.

In April, 1986, the NMML assisted by the University of Alaska Sea Grant program sponsored a workshop to demonstrate a working version of the new computer system to the North Pacific researchers.

Since its inception, the NMML has improved the system. Based on the comments from researchers attending the workshop, a User's Guide is being developed by Mizroch and Beard, and the current version was demonstrated at the recent Seventh Biennial Conference on the Biology of Marine Mammals in Miami, Florida. In addition, the NMML has received photographs from all the North Pacific research groups. It now has nearly 8,000 photographs from over 15 collections, representing perhaps as many as 3,000-4,000 individual whales. Last December the entire North Atlantic and North Pacific collections of photographs was mastered onto a video disc.



Photo-identification techniques have been developed for many other species of whales, and new studies are being initiated for a number of species previously thought to be difficult to identify. Several long term photo-identification studies of individual cetaceans have provided information about migration, distribution, abundance, and population parameters such as reproduction and mortality, but even these long term studies have presented analytical difficulties at times.

The International Whaling Commission is conducting a Comprehensive Assessment of Whale Stocks, and in this

context has agreed to sponsor a Conference on the Use of Non-Lethal Techniques, especially Photo-Identification Techniques to Estimate Cetacean Population Parameters. The Conference will be held in La Jolla, California, and will address such topics as:

- Procedures and problems in data collection
- Criteria for identifying and matching individuals
- Assumptions of analytical methods and models used for estimating population parameters
- Methods of obtaining representative samples from populations
- Sample size requirements for obtaining estimates for different levels of precision



The first days, 29 April through 1 May 1988, will be an open symposium, with a number of talks, posters, and special evening sessions. The next part, 1-4 May 1988, will be a workshop (due to space limitations, by invitation only) that will address a number of the topics listed above. The proceedings of the Conference will be published as an IWC Special Issue. For more information about the symposium, contact:

Sally A. Mizroch  
Northwest and Alaska Fisheries  
Center, NMFS  
National Marine Mammal Lab.  
7600 Sand Point Way, NE, Bldg. 4  
Seattle, Washington 98115  
(206) 526-4045

— Sally Mizroch

*Sally Mizroch is a biologist for the National Marine Fisheries Service Marine Mammal Laboratory and coordinates the humpback whale photo identification program.*

*Drawings show some of the humpback whale fluke patterns used in computer recognition program.*



## Struggling to protect animals in Greece

Since it was founded in 1959, the Greek Animal Welfare Fund has been struggling to protect animals. In Greece, animals face problems which don't exist elsewhere. There is a deep-rooted fear of cats and dogs carrying rabies and echinococcus—both dreaded diseases. And many Greeks abhor euthanasia, so fatally injured and starving animals are left to suffer needlessly. Veterinarians for domestic animals are scarce or non-existent in rural Greece and on many of the smaller islands.

Despite these obstacles, and a lack of Animal Welfare organizations, GAWF has made great strides. In the words of an Athenian lady, "The Greek Animal Welfare Fund should be proud of the change it has brought in Greece in the care of animals. Even though Greece is no paradise for animals, it has ceased to be the hell it was . . ."

Eleanor Close, founder of GAWF and holder of the RSPCA's Victoria Silver Medal, was appalled by what she saw in those early days. Dogs and cats were put into malfunctioning electric chambers with long metal tongs. So she ordered modern equipment and barbiturates from England for humane destruction.



*A starving dog in Greece*

Anesthesia was introduced to the experimental hospitals and vets and attendants were hired by the Society to care for the animals, then housed in dank, dark and evil-smelling basements. Outside pounds were built. Humane slaughter was demonstrated in the municipal abattoirs and the one and only animal shelter in Greece was rebuilt. The cruel traffic in equines exported to Italy for slaughter was exposed and, thanks to the efforts of GAWF and the RSPCA, greatly reduced.

Today, GAWF's main function is to raise funds to help Greek humane societies carry out their work. Though headquartered in England, regular visits are made to Greece to meet with the field workers, government officials and new applicants for help. GAWF took a firm stand against the mass slaughter of migratory birds (Greece has been a major offender) and many of its recom-

mendations were acted upon. Protests are now being made to appropriate ministries and media attention drawn to the barbaric practice of tying up and leaving old horses, donkeys and mules to starve after a life of hard labor. Some are pitched over cliffs and left to die a slow and agonizing death.

Apart from regular financial contributions, GAWF has provided medicine and equipment (including two anesthesia machines), stocked a low-cost clinic in Athens, subsidized spaying and funded the purchase of worn-out equines to give them a merciful end. Recently we helped to provide a proper drainage system for the Salonica Society's shelter. Our most ambitious project to date is to build, in collaboration with the Hellenic Animal Welfare Society of Athens, a model animal rescue center. Over two acres of land have been bought in Peania (Attica) and final plans are being drawn up by an architect and our own veterinary surgeon, David Cuffe.

The Center will be a haven for all animals and provide a unique service in Greece. Adoption and neutering of dogs and cats will be encouraged. There will be stables for sick, old or injured equines and a low cost clinic and advisory service. GAWF has raised £50,000 (\$80,000) and the Greek society will match this for the first phase; much more will be needed to complete the Center.

—Gwen Ware

*Mrs. Ware is the Organizing Secretary for the Greek Animal Welfare Fund. Contributions may be sent to: Greek Animal Welfare Fund, 11 Lower Barn Rd., Purley, Surrey, CR2 1HY, England.*

### Animal Welfare Institute

#### Scientific Committee

Marjorie Anchel, Ph.D.  
Bennett Derby, M.D.  
F. Barbara Orlans, Ph.D.  
Roger Payne, Ph.D.  
Samuel Peacock, M.D.  
John Walsh, M.D.

#### International Committee

Aline S. de Aluja, D.V.M.—Mexico  
T.G. Antikas, D.V.M.—Greece  
Ambassador Tabarak Husain—Bangladesh  
Angela King—United Kingdom  
Simon Muchiru—Kenya  
David Ricardo—Canada  
Godofredo Stutzin—Chile  
Klaus Vestergaard—Denmark

#### Officers

Christine Stevens, President  
Cynthia Wilson, Vice President  
Marjorie Cooke, Secretary  
Roger L. Stevens, Treasurer

#### Directors

John Beary, M.D.  
Madeleine Bemelmans

#### Directors, cont'd

Gerard Bertrand, Ph.D.  
Marjorie Cooke  
Christabel Gough  
David O. Hill  
Sue Hunt  
Freeborn G. Jewett, Jr.  
Christine Stevens  
Aileen Train  
Cynthia Wilson

#### Staff

Patrick Allen, Editorial Consultant  
Jessie Despard, Publications Coordinator  
Rose R. Eck, Administrative Assistant for Communications

Diane Halverson, Research Associate for livestock and poultry  
Lynne Hutchison, Whale Campaign Secretary  
Cathy Liss, Research Associate

Nell Naughton, Mail Order Secretary  
Greta Nilsson, Wildlife Consultant  
Victor Perez, Clerical Assistant  
Laura Swedberg, Administrative Assistant  
Louise Wright, Research Assistant

# Infant pain recognized—now how about animals?

An article entitled "Infants' sense of pain is recognized, finally" appeared recently in the *New York Times*. The author, Philip M. Boffey, was making two main points: one, that because newborn infants do not react as their elders do to what are normally painful stimuli, they were perceived until very recently as organisms too primitive to feel pain; two, that pediatricians were slow, (agonisingly slow for infants operated on without benefit of anesthetic) to abandon this deeply entrenched belief even after fresh neurological evidence had roundly contradicted it.

Belatedly most pediatricians do now accept what mothers have always known—newborns can and do feel pain. And in most American hospitals infants will now receive anesthesia before undergoing major surgery.

Bully for science! But wait—doesn't this whole case bear closely upon a

---

*Only after parents and other laymen raised a cry about needless suffering, and some filed lawsuits, was there enough pressure to change.*

*The long failure to provide anesthesia for newborns provides a salutary reminder that medical practices are sometimes based on flimsy science and erroneous beliefs, and that outside critics can bring an important perspective.*

—Philip M. Boffey  
*New York Times*

---

related issue? In some laboratories and many factory farms, animals are treated as if they were machines rather than

sentient creatures. Unanesthetized animals frequently undergo operations which would be quite unbearably painful to an unanesthetized human.

The blithe assumption is that because these animals do not respond in exactly the same way adult humans do to painful or stressful stimuli, they are not in pain. Although the assumption is now vigorously contested it remains a relic of Cartesian orthodoxy vis-a-vis animals. This being so, perhaps the animal scientists should take a look at the findings of their pediatric colleagues across the tiny neurological divide which separates (or, as some would say, unites) people and animals.

And at the same time maybe some of them might care to re-examine their own positions vis-a-vis the not-so-tiny divide which separates laudable scientific caution from stubborn refusal to give up long-cherished beliefs.

## Video tapes at sea

The Marine Mammal Fund has produced two fine 30-minute video tapes which explore the lives of some of our more prominent marine animals. *Watching the Whales* takes you among nine species of whales and dolphins. *World of the Sea Otter* deals with the social and family life of this "clown of the sea". The tapes, priced at \$39.95, are available from: Marine Mammal Fund, Ft. Mason, Bldg E., San Francisco, CA 94123.



Marine Mammal Fund

*An Orca leaps from the water.*

Animal Welfare Institute  
P.O. Box 3650  
Washington, D.C. 20007

Non-Profit Org.  
U.S. POSTAGE

**PAID**

Washington, D.C.  
Permit No. 2300



# THE ANIMAL WELFARE INSTITUTE QUARTERLY

P.O. BOX 3650

WASHINGTON, DC 20007

SPRING/SUMMER 1988

VOL. 37, NOS. 1&2

## Interior ordered to enforce humane rules

Under pressure from pet industry lobbyists, the US Interior Department tried to withdraw final regulations on Humane and Healthful Transport of Wild Mammals and Birds mandated under the 1981 amendments to the Lacey Act. After six years of foot-dragging, the Fish and Wildlife Service (FWS) published the final regulations 10 November 1987 to take effect 8 February 1988. But two days later after two of the biggest commercial traders in wild birds, in company with the Pet Industry Joint Advisory Council's (PIJAC) chief lobbyist, insisted that they reconsider, FWS published a retraction in the *Federal Register*. Outraged protectors of animals went to court to right this wrong.

Ray Bolze and Margaret Fitzsimmons of the law firm of Howrey and Simon argued the case *pro bono*. The Animal Welfare Institute was the lead

organization joined by the Humane Society of the United States, Society for Animal Protective Legislation, American Humane Association, American Cetacean Society, Animal Protection Institute of America, International Fund for Animal Welfare, The Fund for Animals, International Primate Protection League, and Friends of Animals. PIJAC joined the Department of the Interior attempting to defend its manipulation of the Administrative Procedure Act.

The lawsuit stated:

As recognized by Congress in passing these 1981 Amendments, recent investigations 'uncovered a massive illegal trade in fish and wildlife . . . Evidence indicates that much of this illegal, and highly profitable, trade is handled by well organized large volume operations run by professional criminals.' This 'illegal wildlife trade has grim environmental consequences. It threatens the survival of many species of wildlife . . .'

*continued on page 15*

### INSIDE

House passes elephant conservation bill ..... *page 4*

US bans Burundi ivory .. *page 5*

Tuna industry decimates dolphins ..... *page 10*

1988 IWC meeting ..... *page 12*

News of registered research facilities ..... *page 16*

Undercover operations surface triumphantly..... *page 18*

Very special agents join war on drugs ..... *page 18*

Senate passes pet theft bill ..... *page 20*

## Labelling of furs caught in steel jaw leghold traps

The first proposal for providing consumers with information of the source of the fur made into coats being offered for sale was made by British Minister of Trade and Industry Alan Clark. He stated, "This is a question of public enlightenment, not a statutory thing. It is saying that the public is able to make its own decisions, provided that it knows what is at stake."

The proposed order attracted much interest in Parliament and many Members supported the following resolution:

That this House, noting the intention of the Department of Trade and Industry to introduce a labelling Order to cover the furs of animals caught in leghold traps, a device made illegal in the United Kingdom following the report of the 1951 Scott Henderson Com-



*Opponents of the steeljaw leghold trap, US Congressman James Scheuer and European Parliament Member Barbara Castle at the Parliament's Animal Welfare Exhibit in Strasbourg.*

mittee, which describes it as a diabolical instrument which causes an incalculable amount of suffering, congratulates the Minister for Trade on taking this valuable step, which will allow the consumer to exercise freedom of choice as to whether or not to purchase garments the production of which will have involved extreme cruelty to animals; and calls upon Her Majesty's Government to include in the Order the furs of badger, beaver, bobcat, coyote, cross fox, ermine, fisher, gray fox, lynx, marten, opossum, otter, raccoon, red fox, and wolf, all of which are frequently caught in leghold traps.

The Government of Canada strongly opposed the proposal, allegedly threatening to give a five billion dollar order for submarines to France instead of the United Kingdom if the Order was

*continued on page 8*

# This bird bill deserves passage into law

It was back in 1984 that New York became the first state in the Union to ban the import and sale of wild-caught birds. The measure was aimed at lessening the pressure on parrots and other birds plucked in huge numbers from their forest homes overseas to satisfy our ever-growing cage-bird trade.

Four years on and New York is still the only state to have taken this step. However, now there is a chance that Pennsylvania will follow suit. Hearings on the state's *Wild Bird Bill* HB 2227 took place on 19 May in Harrisburg.

Primary evidence came from the British-based Environmental Investigation Agency whose grim account of the trapping of some 20 million birds a year in Senegal was carried in a previous *Quarterly* (Spring/Summer 1987). In his testimony EIA's Dave Currey showed a 6-minute excerpt from his on-location film graphically illustrating the hideous cruelty and wastage involved in Senegal's bird trade—for which the US is the chief customer.

Predictably though, the vociferous ranks of the pet industry remained quite unmoved by this front-line report. In what the President of AWI, who herself spoke in strong support of the bill, described as a "stormy" meeting, the cage-bird lobbyists were long on invective (castigating the bill's supporters as hysterical propagandists) but short on reasoned argument.

On all matters of substance the bill's opponents were roundly routed. They contended that the proposed ban will lead to an increase in smuggling. Not so, said Dr. Donald Bruning, chairman of IUCN's Parrot Specialist Group. As a resident of New York he made it plain that his state "is not a magnet for attracting smuggled birds."

They, the bill's opponents, contended too that pet stores will not comply with the proposed new law. Not so. In New York state most pet store owners are complying. (Or is the pet industry saying that Pennsylvania's pet store owners are less law-abiding than New York's?) They also contended that because federal laws, as required by CITES, already prohibit the import of threatened and endangered species, any further tightening of the screw is quite unnecessary. Not so. Authoritative estimates suggest the number of birds smuggled into the US may be as high as 100,000 a year—or almost half the number *legally* imported.



Photo: US Customs

Dead smuggled parrot, its feet and beak wrapped in masking tape.

One typical kind of smuggling ring begins in Mexico where parrots are supplied to individuals who transport them across the US border in any of a variety of ways. When automobiles are used, they may be hidden inside door panels, hub caps, under seats, in passengers' garments. Or crates full of birds may be brought across a lonely stretch of river at night and hidden in a prearranged spot to be picked up by a member of the ring on the US side who then distributes the birds to other criminals with the right connections in the bird trade . . . To police the huge American-Mexican border, the Fish and Wildlife Service has only four agents and three inspectors!

— Excerpt from testimony of Christine Stevens at hearings on HB 2227

As things stand pet store owners and, more plausibly, the pet-buying public are able to plead that they cannot tell the difference between smuggled birds and those legitimately brought in. Only a total ban on the import of *all* foreign wild birds can puncture this defense and, in the process, deal a mortal blow to the smugglers.

How so? Because the bill contains a provision to enable anyone to tell at a glance the captive-bred bird. For these birds will sport a seamless leg band that can only be attached in the fledgling state while it can still be slipped over the foot.

Stopping big-time smuggling will have health benefits. In the first place smuggled birds, which evade quarantining, frequently contract psittacosis and transmit it to people. In its human form it is a very nasty disease. Secondly, that scourge of the poultry trade, exotic Newcastle disease, invariably owes its genesis to smuggled wild birds that have escaped.

All in all there is every reason why HB 2227 should become law. Will reason prevail, though? For the state that takes its name from that eminently reasonable man, William Penn, the omens are surely propitious.

---

## Smuggler jailed in Ghana

Darrel Alexander was on board a plane in the West African country of Ghana when officials arrested him for trying to smuggle 2,000 African Grey Parrots. A ban on the export of these parrots has been in effect since 1980.

33 crates of the birds were being loaded when an observer alerted the police. Alexander, who was importing the birds for Exotic Fauna of Los Angeles, also runs USDA quarantine stations in L.A. He is now in a Ghanaian jail along with three others involved: two Ghanaian bird dealers and a Customs Officer.

The parrots were in such poor shape when they were seized that many died. The survivors are now being housed in the Accra Zoo.

# United fined \$11,000 for violations

**T**heir ads invite travelers to “fly the friendly skies” but for animals, the skies of United Airlines have been more fatal than friendly.

Earlier this year, United paid an \$11,000 penalty for violations of the Animal Welfare Act involving nine separate shipments of live animals. Among the list of violations: accepting dogs shipped in kennels of inadequate size, failing to observe and care for the dogs properly and neglecting to supply sufficient ventilation.

In 1985, in the space of four months, two dogs in United's care died while in transit. One year later, another dog was allegedly mishandled, escaped and was killed in traffic. According to the US Department of Agriculture, United also “accepted a shipment of 50 monkeys in cages that were not structurally sound and had no markings indicating they contained wild animals.”

The monkeys, shipped from Japan, were en route to a research facility. Under the law, United could have been

fined \$1,000 for each monkey shipped; a fine which would, perhaps, reduce future violations.

But United is not alone. “This is not an isolated case,” says Fay Brisk, who has been monitoring the care given to animals in transit for the past two decades. She cites a case of four greyhounds who died on their way to Portland from St. Louis when their plane reportedly lost pressure. Two others had to be euthanized after landing. “We don't know how often that happens because we don't have the reports.”

Airlines are not required to report to USDA when an animal in their care dies so there is no way of establishing how many of these deaths are occurring. Occasionally, a pet owner will sue the airline, but pets make up only a small percentage of animals being shipped each day. “We have to remember that many lab animals are shipped by air, as well as wildlife and puppies from puppy mills,” Brisk points out. For this reason, “airports are an excel-

lent place to catch other (Animal Welfare Act) violations, such as unlicensed dealers.”

Despite increased penalties for violations instituted in 1985, animals continue to suffer when traveling by air. One of the reasons is a shortage of USDA inspectors. USDA is responsible for enforcing the Animal Welfare Act, which contains a provision for animals in transit. But they have neither the staff nor the money to effectively police the enormous numbers of animals shipped every day.

“They can't handle it,” says Brisk. With the few inspectors available to inspect airports, “only 20 or 25 major airports can be inspected. Last year they spent \$141,000 on airline inspections; that's around two percent of the total budget of five million (allocated to enforce the Animal Welfare Act) for 1987. It has the lowest priority of any program.” Yet USDA surveyed one major airport and found that over 25% of the 200 shipments examined were in violation of the Animal Welfare Act.

## Survival of the smartest



*Extracted from an article by Jared M. Diamond, Nature, 5 November 1987.*

We take it for granted that social mammals, such as lions, acquire hunting skills only after a lengthy period of watching, imitation and practice. Birds supposedly rely on instinct and are poor at learning. But consider the implications of Werner and Sherry's work for birds living in the world's most species-rich habitats, the continental tropical rainforests.

An insectivorous bird is faced with tens or hundreds of thousands of local insect species, including more than a thousand beetle species in one tree species alone (Erwin, T. *Coleopt*, *Bull.* 36, 74-75; 1982). Many of these species are poisonous or spiny, others are nonpoisonous but closely mimic the poisonous ones, and still others are concealed or evasive.

Each species poses different problems of search and capture. Similarly, a frugivorous bird is faced with hundreds of fruit species, some of them nutritious, others poisonous and others non-poisonous but of low nutritive value. Each fruit species exhibits different external signs of when it is ripe to eat.

Although tropical entomologists and botanists devote their entire professional lives to learning to distinguish a small fraction of a local flora or insect fauna, a tropical-forest bird must master this enormous amount of local information more quickly if it is to survive. Juveniles spend months foraging with their parents after fledging, and many species forage in mixed-species flocks outside the breeding season.

These behaviours could provide the schools for learning. The penalty for failing avian examinations is severe: many juvenile birds in Sarawak forest die of starvation and other causes within a few weeks after dispersing (Fogden, M. *Ibis* 114, 307-342; 1972). Thus, tropical-rainforest birds may have been selected for learning ability.

**T**o keep the airlines on their toes and catch violations, USDA inspectors must make unannounced visits. But often when the inspector arrives, the animal shipment has left or hasn't come in yet. “USDA ought to have an idea of when large shipments come in...Most arrive in the morning or at night,” says Brisk. This is especially important since inspections may be few and far between.

Ultimately, it is up to the airline to improve the treatment of the animals they carry. One simple but important change airlines can make is to change the category under which animals are shipped. Currently, though the animals' crates must be marked ‘live animals,’ the shipping manifest offers only two choices: ‘freight’ or ‘cargo’. “If they are going to label them baggage, they'll be handled like baggage,” says Brisk, adding that there is no separate compartment for animals once they are placed in the plane.

For those animals on the ground, she suggests involving local humane societies. “if they can make an arrangement with the airlines to have a humane agent to go in and check the animals, not as an agent of the law, but as a public service to assist the airlines, I think the airlines would welcome that.”

# Elephant Conservation Bill passes House

The disastrous decline of the African elephant as a result of the ivory trade was discussed at hearings 22 June.

Congressman Gerry Studds, who chairs the Subcommittee on Fisheries and Wildlife Conservation and the Environment, outlined the three proposals: Congressman Anthony Beilenson's H.R. 2999 to ban importation of elephant ivory; Congressman Jack Fields' H.R. 4849 to ban importation of ivory from "intermediary" countries; and a staff draft requiring effective conservation programs.

The bill approved by the Subcommittee, passed the full House on Monday, the eighth of August and awaits action by the Senate Finance Committee.

The powerful testimony of Dr. Iain Douglas-Hamilton brought home the extent of the disaster in populations which he and other scientists have studied over the past 15 years. Figures



the Convention on International Trade in Endangered Species of Wild Fauna and Flora (CITES), Dr. Douglas-Hamilton said:

The CITES Ivory Quota agreement,

when I fly surveys each time I find fewer elephants left alive, and thousands of carcasses, some killed in the last few years and some recently. I know that it is the ivory trade which is responsible, and even as we talk, elephants are being killed for ivory.

The quota system is not working. In 1986 it was estimated that only 22% of the ivory traded on the world market was legal. It hasn't worked in the past and all the signs are that it will not work in the future. There are too many middlemen. There are too many ways for the ivory to get into the world trade . . .

The whole system at present is out of control. There isn't time to get proper controls. The traders are too clever at finding loopholes. One only has to look at the rhino situation to see what will happen to the elephant. The only merit of the system is if it can lead to united international police action to eliminate the illegal ivory trade. This is what I recommended to your committee in 1979,

Country*	Number of Elephants		Decline	
	1973	1987	Numbers	%
Kenya	130,570	19,749	-110,821	(-85%)
Uganda	17,620	1,855	15,765	(-89%)
	1977	1987		
Tanzania	184,872	87,088	-97,784	(-53%)

showing the widespread decimation appear above.

"Recently," Dr. Douglas-Hamilton stated, "even supposedly small and well protected elephant populations have collapsed. For example, the elephants of Lake Manyara live in a small and isolated park and I have been studying them for 20 years, and have flown periodic aerial surveys. At one time I knew 400 of them individually. The numbers counted from the air gently increased from about 300 in 1967 to 485 in 1981, but in the last two years over half the elephants have been lost. In November last year we counted 181 live elephants and 94 dead. Of the 25 or so old matriarchs that I knew there were only three left, and no large bulls survived. It was as if a whole elder generation had been wiped out."

Of the much touted quota system of

conceived in 1984, came into effect in 1985 and was intended to control the trade in ivory. In theory strict controls on all ivory were to be instituted. Each tusk was to be registered at source, and tracked by a computer. Rapid communications were to be set up between the management authorities of producer and consumer countries in order to catch illicit traders. In practice the computer registration happens, but with a few notable exceptions the rapid communication and the crime busting capability has not materialized.

Yet it was claimed in 1986 by the CITES secretariat that the system had already reduced poaching. This simply is not true. The surveys in which I have participated show how ivory poaching has continued to decimate elephant populations.

As a field biologist I am perplexed by all the claims made by the trade that the offtake is sustainable. I only know that

but it has not happened.

He predicts:

As the elephants become scarcer the price will continue to rise. Even now the demand of Hong Kong, Japan, Europe and America cannot be met. It was thought that when the large Singapore ivory stock of 297 tonnes came on the market in the latter half of 1987, that the price of ivory would fall. It did not. It continued to climb up to \$150/kg and beyond. At present levels of demand we can expect the price to go on up through the roof.

He concluded that "The time for action is now, not when the elephants have followed the route of the rhinoceros" and recommended "eliminating the role of the United States in creating a demand for ivory is crucial if we are to reduce the volume of ivory being consumed by the developed world."



In recognition of twenty years of work to save the African elephant, Congressman Anthony Beilenson presents Dr. Iain Douglas-Hamilton with a statuette created by sculptor John Perry.

Photo: Rosita Eck

## April: US bans Burundi ivory August: Burundi joins CITES and jails ivory dealer

As from 29 April the US has banned all imports of ivory from Burundi and warns that it will extend the ban to other nations trading in ivory with this East African country. The US action follows the discovery, confirmed by CITES, of 16,000 elephant tusks (which means at least 8000 dead elephants) in private ownership in Burundi.

This vast haul of ivory has accumulated since 1 December 1986, by which date Burundi's stockpiled ivory had to be registered with CITES if it was to be allowed into international trade. The controversial deal—which enraged several African nations, not to mention the conservation community, when it later came to light—was sanctioned by the CITES Secretariat on the strength (if that's the word) of Burundi's promise to become a party to the Convention.

The promise proved empty. After "legally" selling off no fewer than



Photo: African Wildlife Federation

*Elephant tusks. Note the steel jaw leghold traps piled in the background.*

18,148 CITES-registered tusks, Burundi ceased all further communication with the CITES Secretariat.

Now, less than 18 months later, this tiny country, which has no elephants of

its own and to which no elephant nation has authorized any exports of ivory, has yet managed to stockpile ivory almost to the level of December 1986.

Most and perhaps all of this ivory was poached. There can also be no doubt that it will be traded internationally unless prohibitions are imposed fast throughout the international community. Other countries are therefore being urged to follow the US lead.

### STOP PRESS!

Burundi has ratified the Convention on International Trade in Endangered Species of Wild Fauna and Flora (CITES) and will officially become a party to the Convention 8 November 1988. The Burundi government reportedly took all the stockpiled ivory into custody, but an undisclosed amount is missing. One trader has been jailed. The remaining 108 tons is worth about \$200 million.

## The rhino in peril—"we are really fighting a war"

Congressman James Scheuer called hearings on "Conservation Strategies/Saving the Endangered Rhinoceros" in the Subcommittee on Natural Resources, Agricultural Research and Environment, which he chairs. The hearings followed those held on elephants in the morning of June 22nd.

In his opening statement, Congressman Scheuer said:

Rhinos have been on the Earth for 30 million years, much longer than our own not-so-humble species. For millennia, rhinos have thrived, populating Africa, India, and much of the Near East, and even reaching the East Indies. Today, rhinos are reduced to remnant populations, persisting only in protected pockets, under the watchful eye of armed wardens. We have assailed the habitat of rhinos, causing their population to plummet as our own human population soars exponentially to disaster.

More recently, the destruction has been even more direct as poachers have killed tens of thousands of rhinos. Only the horn is taken. It is sold at exorbitant prices to be made into daggers for North Yemen or pulverized into powder to fulfill the fanciers of Oriental folklore.

At the turn of the century there were more than one million rhinos in Africa alone, but today less than 3,500 black rhinos remain. All other species of rhinos are also imperiled. This Subcommittee held hearings in the 99th Congress that led to Singapore signing

*At the turn of the century  
there were more than one million  
rhinos in Africa alone,  
but today less than 3,500  
black rhinos remain.*

CITES (Convention on International Trade in Endangered Species), greatly reducing the illegal trade in rhino products.

... Rhinos are symbolic of our effort to preserve biological diversity. We are losing biological diversity at an unprecedented rate. By the end of the century, scientists estimate that we may lose as much as 25 percent of the world's animal and plant species. If the rhinos go extinct on our watch, we will have only our own species to blame.

Rhino expert Esmond Bradley Martin called for strong diplomatic pressure on the United Arab Emirates whose Minister of Commerce and Industry promised to close down the trade in rhino horn. However, nothing has been done. He stated that Zambia was

causing the single biggest problem in Africa with respect to rhino poaching.

Dr. Willie Nduku, Director of Zimbabwe's National Parks, said they are waging a war against the poachers. Some are financed, he said, by "people from across the waters." Questions by Congresswoman Claudine Schneider brought out the fact that the same people are involved in trafficking of drugs, diamonds, gold, and rhino horn. Dr. Nduku stated, "They use military equipment for fighting back [against the game wardens], so we are really fighting a war."

In questioning the panel of rhino experts, Congressman Scheuer said he understood that in many cases poachers were really out there to kill elephants, but when they found rhinos, made them a "secondary target." Dr. Iain Douglas-Hamilton, who joined the rhino expert panel at the request of the Chairman, responded, "Rhinos will not be protected by rarity because poachers can still make an easy living off elephants." He pointed out that the same people are poaching both species.



# Insider's view of pesticide ado

Two industry publications, *Agri Marketing* and *Agri News* recently ran commentary by Ciba-Geigy's Director of Communications, Phil Koch. Following are excerpts:

When are we in the pesticide industry going to come to our senses and stop advertising pesticides on television? The ag-chemical industry adds to its own problems with continued massive spending on a medium that provides the weapon—if not the ammunition—used in shooting one's self in the foot.

All of us have known how inefficient TV is—95 percent of our viewing audience being non-farmers. But over the years, we could see the value of its impact and awareness unmatched by other media. The total acreage potential of the TV buy made it worthwhile as cost-per-thousand acres of a target crop seemed reasonable. Forget the ineffi-

ciency. The message segmented the audience; the 95 percent non-farmers tuned it out. . .

That's a valid rationale as long as the 95 percent is neutral—doesn't care—in fact, does tune out.

There's a big change that's come about in the non-farm 95 percent. They're not tuning out. . .

State legislators, sensitive to changing winds and encouraged by environmentalists, muster local support for groundwater, pesticide control, endangered species and other anti-pesticide legislation. They are getting it from all those non-farmers—the 95 percent that never really tuned out. . .

In recent months, I have received

serious pleas from farm leaders, and at least five letters from commodity groups urging us and others in our industry to cut out TV ads. These aren't the "cut your advertising and sell cheaper" pleas. They're from front-line agriculturalists fighting the battle of image and opinion influence. . .

There are smarter ways of spending big bucks on a decreasing number of farmers, and we're less apt to contribute to the growing negative image and misperception of pesticide abuse that will come back to haunt us.

*Phil Koch is director of communications for Ciba-Geigy Corp., Greensboro, N.C.*

Reprinted from *Agri-News*, 7 April 1988.

## There can be no victory in the war against the tsetse fly



High on the list of loony development programs foisted on developing nations by the international aid lobby must be a project sponsored by the European Economic Community on behalf of the third world countries of southern Africa. It requires the elimination of the tsetse fly so that domestic cattle (which are vulnerable to tsetse-spread disease) may supplant the region's abundant wildlife (which cannot be harmed by the tsetse) in order to add to the European beef mountain.

Where the goal is purposeless while the means to achieving it are highly destructive, there you have lunacy of a pretty high order.

After many years of costly and strenuous endeavor, the main "fruits" of the project to date include: cruel inroads into wildlife populations to make room for the cattle; potentially disastrous losses amongst animals at the top of the food chain, notably birds of prey, due to repeated spraying of DDT in generous quantities across huge tracts of land; increasing desertification where cattle have been moved in; increasing pauperization of the very people whom the project is designed to assist.

AWI has received a first-hand report on the anti-tsetse campaign in the

Zambezi Valley of northern Zimbabwe. It comes from Ian Sinclair and makes sad reading.

Referring to the unauthorized influx of settlers with their livestock into areas cleared of the fly, he tells us that the resulting land degradation is such that the EEC has given up trying to promote sound policies of land-use and "is washing its hands of the chaotic mess." He states, "The introduction of cattle and cash crop farming into these areas will create deserts within five years."

On a more upbeat note, however, he tells of a new project sponsored by Zimbabwe National Parks known as *Operation Campfire*. Here in southern Zimbabwe "cattle and plough have been discarded for the more lucrative game." Careful use of the wildlife has netted the project and the local people involved (who receive cash and a continual supply of meat) more in one season than cattle ranching could be expected to produce in 5-6 years.

Nor do the benefits stop there. The soil remains in good shape, over half the income is in the form of foreign exchange and the people willingly abide by the management plan because it closely accords with their traditional practices.

A recent issue of *Zimbabwe Science News* also comes down firmly in favor of wildlife ranching as against cattle. Looked at from whatever angle—economics, the environment, the local people—the case for large-scale cattle farming on the vulnerable soils of these southern African countries is a case that does not add up.

In a fundamental sense the tsetse fly is the prime defender of the life and fertility of these areas. Attempting to eradicate the tsetse in order to introduce cattle can only do irreversible hurt to land, wildlife and people.

In any case, in the view of many experts, the attempt is itself foredoomed. Failing total elimination of the tsetse throughout the region, a herculean task, recolonization from uncleared areas to cleared areas is only too likely.

As for the threat posed to human health by the tsetse, this should be seen in perspective. While sleeping sickness is certainly a nasty complaint it is very seldom fatal—just five recorded cases in 25 years.

One way or another the moral would seem to be plain: *Live and let live*. Or as Ian Sinclair puts it: "The land has already been developed by nature to its full potential."

# STRYCHNINE RESTRICTED

Last April in what was hailed as “the most broad-ranging opinion ever issued under the Endangered Species Act” US District Judge Diana Murphy ruled that the Environmental Protection Agency had violated the ESA in permitting farmers and ranchers to use strychnine-laced bait to control pests. Her nationwide ban on its future use above ground will remain in perpetuity unless the EPA can demonstrate how this virulent and intensely painful poison can be applied so as to destroy only target species.

In their suit filed in August 1986 against the EPA, environmental bodies had supplied Murphy with documents

reporting the “accidental” killing by strychnine of five condors, six peregrine falcons, 15 golden eagles, 31 bald eagles and 724 other birds and mammals across 24 states. And that was only recorded mortalities. Undoubtedly on the vast and sparsely populated ranges the deaths from strychnine poisoning of huge numbers of protected animals have gone quite unrecorded.

Murphy determined that in recent years up to 200 tons of the deadly and viciously unselective baited carcasses have been used annually, chiefly in western states. But now, praise be, that’s one hazard our embattled wildlife need no longer face.

## Redwoods felled to fuel debt repayment

A great swathe of northern California’s coastline is fast being denuded of its age-old redwood forests. America’s largest privately owned virgin redwoods now belong to the Maxxam Group under the directorship of Houston financier, Charles E. Hurwitz. He has doubled the rate of felling within his 300-square-mile fiefdom in order

the future.”

For it is not just a matter of rapid felling. It is a rapacious and destructive onslaught in which towering virgin tracts are losing *all* their trees, many of them over 1000 years old. Clear-cutting, a dubious practice at the best of times, is downright wicked in the climate of northern California. A former logger explains: “We get monsoons here eight months of the year; soil is drained off the land. But people are afraid to speak up. They’re stuck here. They can’t afford to move out.”

Maxxam are not, however, having it all their own way. Environmentalists, supported by many loggers and saw-mill workers appalled by the company’s actions, have won court decisions blocking harvesting in several areas. Two bills have been introduced in the California Legislature to prohibit

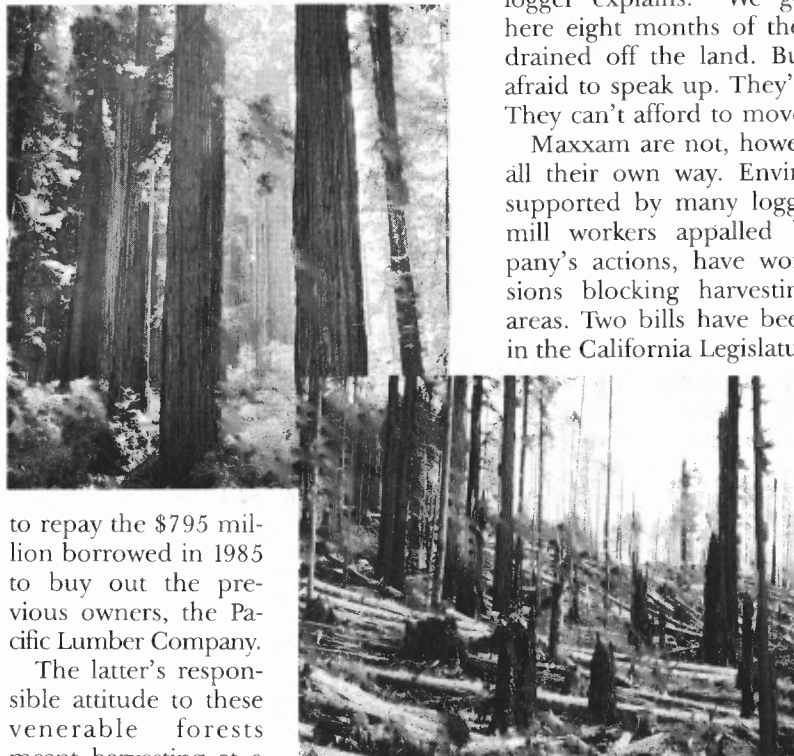

Redwoods:  
an old  
growth (top)  
and clearcut  
(left).

to repay the \$795 million borrowed in 1985 to buy out the previous owners, the Pacific Lumber Company.

The latter’s responsible attitude to these venerable forests meant harvesting at a gentle pace to preserve the oldest stands well into the 21st century. This contrasts sharply with Maxxam’s policy of—in the words of a former employee—“just chewing so there won’t be anything left for

logging companies from cutting more timber than they grow. A number of alleged irregularities in the takeover of Pacific Lumber by the Maxxam Group are also under investigation.

## A donor’s disillusionment

On the outskirts of Washington neighboring Virginia is the Claude Moore Conservation Education Center comprising 357 acres of ponds, cat-tail marsh, meadows and woods.

For over a decade the Center was run by the National Wildlife Federation under the terms of an agreement made with donor Claude Moore. To guard against any possible misunderstanding, before committing his property to the trusteeship of America’s biggest and wealthiest conservation body, Dr. Moore required all 20 or so members of NWF’s board to sign a letter stipulating that the land remain for all time a nature education sanctuary.

But the board of NWF voted to sell the Center to developers for \$8.5 million. They plan to erect 1,350 houses, condominiums and apartments on these 357 ‘inviolable’ acres, keeping just 53 acres, the minimum required by law, as open space.

Outrage from many quarters greeted this act of bad faith, not least from Claude Moore himself, now a spritely 97. In June of 1987 he filed suit charging the Federation with “fraud and deceit” and demanding the return of his property.

A whirlwind of litigation has followed since that time. In March of this year, Moore withdrew the original suit and refiled with broader allegations. The new suit alleged that the Federation exchanged land for cash throughout the country, and cited examples in both New York and California.

Though the Judge ruled in favor of the NWF on Moore’s charge that the federation has acted deceitfully nationwide, he gave Moore 21 days to replead. Moore did just that, and has not given up the fight to save the sanctuary from development.

Meanwhile, the developers requested that the land be rezoned so that they may build, but, the Loudon County Board of Supervisors has denied their request. They would like to buy the property themselves to ensure that the wildlife, which includes the rare Henslow’s sparrow, is not ousted from its home.

Where once money was raised to buy sanctuaries, now ‘unprofitable’ sanctuaries (the Moore property is not the only example) are sold to raise money.

The application of a strictly business approach plainly pays off. By 1986 NWF claimed to have 4.8 million “members and supporters” and a budget of close to \$60 million—money that must go to pay for computers and other pricey hardware to aid research on endangered species, not to mention a spanking new headquarters in downtown Washington.

While pondering these matters it is as well to remember that NWF, alone of the big conservation bodies, continues to advocate the use of the steel-jaw leghold trap.

# Please help stop this barbarous custom

Are you off to the Olympic Games in Seoul? Then, as you tour the South Korean capital, you're quite likely to see dogs in cages strapped to the backs of bikes and mopeds. But where are they going? No, they are not about to be exhibited at some friendly local dog

hundreds, dog-meat soup and basted dog meat are staple fare. Menus are openly displayed even though "dog shops" are officially illegal. Large sums of money are involved in sale of dogs and dog meat.

We ask you to write to one or both of



*Dogs being transported to market where they will be sold for human consumption.*

show. They are off to market—the restaurant market.

These dogs suffer from extreme overcrowding on their way to market for slaughter. Puppies are crammed into tiny cages which are stacked on top of one another while large dogs are often piled together in the same cage.

Once arrived at the "dog shops" they will be unloaded and crammed cheek by jowl into other cages, there to stay until sold for consumption. Their wait may be a long one; their sustenance meager.

A study by the World Society for the Protection of Animals reports that Koreans believe dog meat has many medicinal qualities, not least that it gives protection from heat-induced ills because dogs do not sweat. Dog meat is therefore especially popular in summer.

Dog-breeding farms ensure that supply keeps pace with demand. In the restaurants, which range in size from shacks to mansions capable of seating

South Korea's diplomatic representatives in the US to inform them that you are aware that dog-eating is against the law but remains widespread throughout all sections of Korean society.

Ask that the government 1) immediately expand the law to cover all transport, handling, confinement and killing of these dogs and 2) provide effective enforcement to prevent the ongoing cruelty.

The addresses are:

His Excellency Kyung-Won Kim  
Ambassador of The Republic of Korea  
to the United States  
2370 Massachusetts Ave., NW  
Washington, DC 20008

His Excellency Dr. Keun Park  
Ambassador of the Permanent Mission  
of The Republic of Korea to  
the United Nations  
866 United Nations Plaza  
New York, NY 10017

## *Labelling of furs caught in steel jaw leghold traps*

*continued from page 1*

approved by Mrs. Thatcher. The US State Department opposed it, too, and submitted material collected from a variety of sources (carefully avoiding any consultations with animal welfare organizations) as back-up.

Thirty-three members of the House of Representatives addressed a letter to the Prime Minister in support of the Order, but just before the summit meeting in Toronto, the UK government rejected the Order. A question in the House of Commons (23 June 1988 *Hansard*) demanded: "Was that proposal reversed to smooth the Prime Minister's way in Toronto or to sell submarines?"

In the European Parliament questions on fur labelling have twice been raised by Madron Seligman, Chairman of Intergroup on Animal Welfare, an organization composed of members of the European Parliament committed to animal protection. Mr. Seligman has emphasized the public's "deep concern and moral outrage about the trapping by means of leghold traps of fur-bearing animals and the use of their fur in consumer products."

Recommendations of the European Parliament must be approved by the European Commission before binding directives are issued. The remarks by Commissioner Stanley Clinton Davis in his speech to Intergroup for Animal Welfare 7 July are thus of major interest. Mr. Davis is responsible for all animal welfare issues other than those relating to agriculture. He reported briefly but trenchantly on fifteen different broad fields of concern. Under the heading of *Fur*, he said:

As members well know, the United Kingdom notified to the commission under directive 83/189/EEC a proposal to label furs of certain species commonly caught in leghold traps so that consumers may be better informed and may be able to choose accordingly. That notification was recently withdrawn by the United Kingdom, the UK legal authorities having decided that the legal instrument to be used was not in fact suited for this particular purpose.

The UK proposal was of course of considerable interest to the commission, both from the trade and the animal welfare point of view. In the context of the Europe of 1992, and

the need to avoid internal barriers to trade, it could be argued that community measures are in any case to be preferred to national measures.

I can now announce the following:

- The commission will be making a proposal, in the context of the new draft directive on the protection of habitat and of wild fauna and flora for a total ban within the community on the manufacture, sale and use of leghold traps. (In this connection, I note with interest the motion for resolution tabled under rule 63 by Barbara Castle and others urging us to do precisely this).
- I have also instructed my services to prepare urgently a proposal for a community fur labelling rule, drawing whatever inspiration may be appropriate from the draft order presented by the United Kingdom. I hope it will be possible to make such a proposal before the end of the year. In this connection I note that a motion for the register has been tabled under rule 65 by Barbara Castle and Madron Seligman "calling on the commission immediately to introduce proposals for the labelling of fur products imported into the EEC to indicate whether they derive from animals caught in (steel-jawed leghold) traps."

Congressman James Scheuer (D-NY) who has long sought an end to the use of the steel jaw leghold trap in the United States was invited to speak at the Intergroup meeting. He characterized Commissioner Davis' report as inspirational and commended the "broad array of issues on which you are showing leadership." He praised in particular the move for fur labelling which he said would have a powerful influence because Europe is the largest market for American and Canadian fur. "I value your commitment," he

said, "to abolishing steel jaw leghold traps. The environmental ethic links us with everything decent and civilized. Animals have a right to respect from us. We should view ourselves not as conquerors of the earth but as fellow travellers with them."

He spoke, too, of the reductions in numbers of elephants and rhinos, the latter disappearing at a rate of 50% every year after prospering for sixty million years "... until they met man. We are the ultimate predator. It is a shame and disgrace that we are."

Congressman Scheuer concluded by emphasizing the interconnectedness of animal welfare and environmental issues, the bulldozer, axe and buzz saw destroying animals' habitat, destruction of the ozone shield, misuse of CFC's (which he pointed out DuPont itself said must not wait for years to be phased out), global warming. "Nature," he said, "is sending shots across the bow ... calling on us to summon up our finest instincts."

Mrs. Barbara Castle, MEP characterized the meeting as an historic occasion. A vigorous and effective leader, Mrs. Castle organized the animal welfare exhibition at the Parliament, opened on 6 July where powerful videos and displays against the steel jaw trap, clubbing of baby seals, cruel entertainments such as bullfighting, and cruel treatment of stray dogs were shown.

"We will have a Directive banning the use and sale of these traps in the Community, but that is not enough," she said, "The next step will be more difficult. We should be fighting for labelling." She cited figures of 12 million fur pelts from the United States and 2.6 million from Canada imported into the EC each year, 50% of which are trapped—"a mass trade in misery."

## TAMING THE TRAPPERS

The biggest fur-trapping enterprise in the world, the Hudson's Bay Company, is quietly collapsing after nearly three hundred years of violent exploitation of beavers, wolves, foxes, lynx, martin, and other inhabitants of Canada whose fur could be sold for profit.

True, the British royal family still owns shares in *The Company of Adventurers*, as the corporate giant has enjoyed calling itself all these years, but HBC's adventures have largely shifted to discount stores, department stores, and real estate, under the guidance of billionaire majority stockholder, Kenneth Thomson.

Indian trappers sing songs to ward off the evil spirits they believe inhabit the empty *York Factory*, HBC's chief headquarters in the seventeenth and eighteenth centuries. HBC's northern stores, now owned by the Mutual Trust Company, were traditionally unheated trading posts where Indians could obtain guns, traps, and staple foods in return for beaver pelts.

According to a *National Geographic* article, "It was not until the 1960s that the company finally began to heat its northern stores ... 'They didn't want anybody hanging around—they wanted everybody out trapping,' recalls Stuart Hodgson, who served 12 years as commissioner of the Northwest Territories."

The Hudson's Bay Company was responsible for making Canadian native people dependent on the steel-jaw leghold trap. To quote again from the *Geographic* article, "... the Indians were anxious to supply pelts in return for goods that transported them instantaneously from the Stone Age."

The fur trade continues to exploit native trappers and to disregard them when it is convenient to the industry to do so. An example is the widespread sale of captive-bred arctic foxes whose fur is a more perfect white than that of arctic foxes trapped in the wild. At the same time, the industry pushes native trappers into the front ranks when they wish to make their advocacy of the steel-jaw leghold trap seem as though it were based on sympathy with the very native peoples they have exploited.

Contributions to the Animal Welfare Institute are deductible in computing income tax returns, and donations, large or small, are most gratefully accepted for the general fund or for special purposes. Bequests to the Institute will help guarantee the continuance of its 37 years of work to protect animals. Please remember the Institute in your Will.

The Board of Directors suggest the following language for use in Wills when making a bequest to the Animal Welfare Institute:

"I give to the Animal Welfare Institute the sum of \_\_\_\_\_ dollars."

(or if other property, describe the property)

For further information on planning your Will, write to AWI at P.O. Box 3650, Washington, DC 20007.

# TUNA INDUSTRY DECIMATES DOLPHINS

The Marine Mammal Protection Act, passed in 1972, is up for Congressional reauthorization this year, and hearings were held 10 May 1988 in the Fisheries, Wildlife Conservation and Environment Subcommittee of the House Merchant Marine and Fisheries Committee. The most heavily contested part of this landmark legislation relates to the so-called incidental catch of dolphins in giant tuna purse seines in the Eastern Tropical Pacific.

Greenpeace spoke for 19 humane and conservation groups, documenting the disastrous destruction of dolphins in the huge tuna purse seines:

... the time has come to return to the original goal of the Act and mandate a zero mortality level. We would point out that this carnage is not an



A tuna boat sets sail for Costa Rica.

'incidental' take—it is an intentional take. Unlike other fisheries with marine mammal kills, these dolphins are not passively taken when they encounter fishing gear. Rather, it involves a take which is deliberate under the definition of 'take' in the Act. It is a purposeful hunting, harassment, capture and, in some cases, killing of marine mammals.

The figures are alarming, and the testimony continues, "We believe, however, that mortality estimates issued by the National Marine Fisheries Service [NMFS] and the American Tropical Tuna Commission are but a fraction of the actual lethal take."

There are several reasons for this; for example, "... no

provisions are made in mortality estimates for cryptic kills, i.e., animals released from the net which may later die from shock, stress or unseen injuries. Over 2 million animals are taken each year by the US fleet alone."

The same school of dolphins may be rounded up and caught in the net several times in a single day. This cruel harassment is especially hard on infant and aged dolphins who cannot endure the repeated stress.

Dolphin defenders won a series of lawsuits against the tuna industry which forced US tuna boats to modify the fishing methods they had invented to compete with labor-intensive Japanese long-liners. But despite the intent of the law to require foreign purse seiners to adhere to US regulations, the Marine Mammal Protection Act has never been enforced against Mexican and other foreign purse seiners.

Purse seiners locate schools of yellow fin tuna by observing the dolphins who swim with them. Because dolphins are air-breathing mammals, they must surface frequently. The big tuna boat sends out small motorboats to round up the dolphin school and encircle both dolphin and tuna with the huge net which is then closed like a purse string. US



Dolphins entangled in tuna purse seine into which they were deliberately driven.

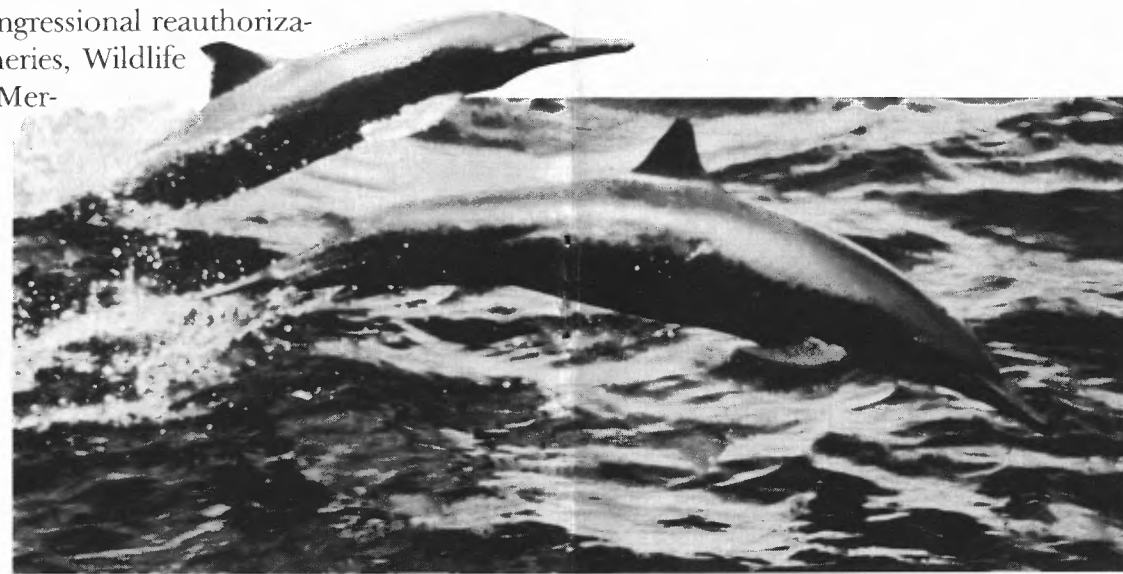

## A first hand account of the slaughter

January 1, 1988—Aboard ship a new year dawns lavender above a tranquil sea. The main engine rumbles to life and a course is set for Costa Rica. We have just received permission to fish in that country's territorial waters. In honor of the occasion and to celebrate the beginning of a new year we travel to within a few miles of the mainland and kill 5-10 percent of the world's populations of Costa Rican spinner dolphins before lunchtime. Rounded up with the use of speedboats and explosives, some 2000 dolphins are intentionally captured in an effort to harvest the yellowfin tuna swimming below the herd. I watch helplessly as hundreds of dolphins become trapped under the walls of the net and struggle furiously, their shrieks and squeals audible even above the drone of the machinery.

As the net is hauled aboard ship, scores of dolphins become snagged in the mesh and are hoisted aloft out of the water. Thrashing and flailing in their efforts to free themselves from the net, many of the dolphins actually have their beaks and flippers broken or ripped right out of their bodies as they fall back to the sea only to become ensnared once again moments later. Many more are too exhausted or embroiled in the net to escape and are literally crushed alive in the hydraulic power block that is used to retrieve the net. Most of these die immediately but a few survive a few moments longer and I watch as they are untangled from the net, their spasms of pain no less real for the brevity of their duration.

The net is finally close-hauled and the crew descends into the net to remove about 200 drowned dolphins. Young and old alike, the dolphins are cast adrift in the waves, magnificent creatures reduced to nothing more than compost and sharkbait. As the last dolphins are thrown clear of the net it becomes apparent that nearly all the tuna escaped the encirclement. No more than eight tuna have been captured at a cost of hundreds of dolphin deaths.

—Samuel LaBudde

Video stills courtesy of Samuel LaBudde/Earth Island Institute

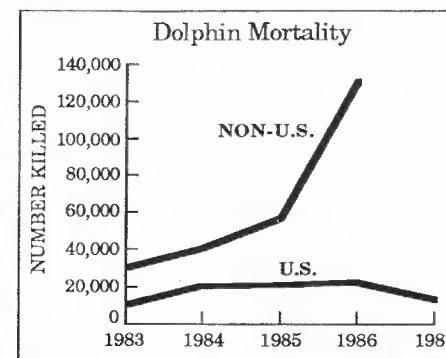

fishermen are required to back down, lowering the back of the net so the dolphins can leap over the cork line and escape. But the numbers of government observers on the US tuna fleet have been greatly reduced, and there are none on foreign vessels at all.

The terrible suffering undergone by the dolphins has been documented by Sam LaBudde, a former US government biologist who went undercover as a crew member on a foreign tuna boat and got extensive film footage. He stated, in part: "Listening to 500 dolphins shrieking in panic as they fight and gasp for air... standing by helplessly as living dolphins were dragged aloft thrashing and flailing in terror before being literally crushed to death in the power block... it's enough to make you give up tuna for life."

There can be no dispute about the numbing cruelty of these mass drownings of highly intelligent and sensitive animals. But what of their effect on dolphin populations? The industry asserts that they are healthy. The experts, the genuine experts, think otherwise. US dolphin biologist Dr. Wil-



Crew members remove dead dolphins from purse seines. Only eight tuna were captured on this set which killed hundreds of dolphins.

liam Perrin writing in the IUCN Bulletin, states that since the 1960s the population of the eastern spinner dolphin is estimated to have declined by no less than 80%.

When the Marine Mammal Protection Act was passed in 1972, US vessels were responsible for most of the catch in the Eastern Tropical Pacific using purse seine nets. The Act called for a goal approaching zero mortality and serious injury rate of dolphins in the purse seine tuna fishery. At the time, hundreds of thousands of dolphins were being killed, and this was ratcheted down to 20,500, but the increase in foreign tuna fishing has brought those numbers up to more than 100,000—the largest slaughter of marine mammals in the world. Today the foreign purse seiners greatly outnumber American tuna boats, and NMFS has failed to take any effective action to enforce the provisions of the Marine Mammal Protection Act with respect to foreign tuna captains.

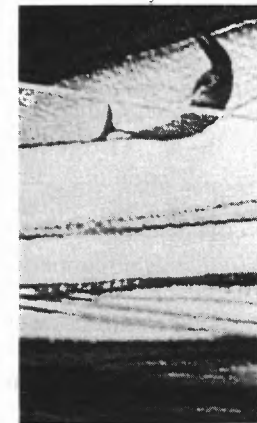

A living dolphin, crushed by the hydraulic power block.

Fortunately, on 13 April a motion for resolution was introduced in the European Parliament which could result in a total ban of tuna caught by setting on dolphins.

The motion has received support from representatives of each of the parties within the Parliament and is being sponsored by the chairs and vice chairs of the two committees which have jurisdiction.

If the United States and the European Community prohibit

continued on page 15

## IWC condemns "research" whaling but Iceland, Norway and Japan continue their defiance

The 1988 annual meeting of the International Whaling Commission, in Auckland, New Zealand in June, adopted resolutions rejecting the proposed research whaling schemes of Iceland and Norway and directed Japan to desist from any research whaling until the IWC has fully reviewed any new schemes. Last year the Japanese fleet began whaling before the IWC completed a postal vote condemning the kill. All three nations are attempting to continue commercial whaling under the guise of scientific research.

Iceland, which defied IWC opposition in 1987, again ignored a 1988 resolution and began whaling shortly after the IWC meeting. Unfortunately, the US, which has enforced IWC regulations in the past by threatening sanctions against the fishing industries of defiant whaling nations, capitulated to Icelandic pressure and made a bilateral agreement condoning the kill.

The US apparently made a secret deal with Iceland to allow another "research" whaling season in spite of Iceland's failure to gain the support of the IWC's Scientific Committee and the full commission.

Iceland used threats against the strategic US airbase at Keflavik—a vital link in the surveillance of the Soviet fleet—to force the US to accept its whaling scheme. Because of the threats to the airbase, the Defense Department and the National Security Council (NSC) entered into US policy-making on the whaling issue. An NSC staffer was on the US delegation to the IWC meeting and it was obvious that the US commissioner to the IWC, Dr. William Evans, was under orders to placate the Icelanders.

Shortly after the IWC meeting, an 8-man US delegation flew to Iceland and negotiated a bilateral agreement in which the US found the planned kill of 68 fin whales and 10 sei whales would not "diminish the effectiveness" of the IWC's whale conservation program.

That finding, expressed in an official letter from the US ambassador to the Icelandic foreign minister, means that the

### STOP PRESS

3 August 1988. Acting pro bono on behalf of the Animal Welfare Institute and 17 other conservation and animal welfare groups, Arnold & Porter filed suit against Secretary of State George Shultz and Secretary of Commerce William Verity for failure to certify Iceland for its "research" whaling.

US will not certify Iceland under the Pelly Amendment. Certification authorizes the president to embargo the fishery products of the offending nation.

Iceland, whose major industry is fishing and whose fish exports provide more than 70% of export earnings, does not want to risk an embargo by the US, which imports about 30% of Iceland's fish. The US capitulation was an extraordinary reversal from positions in 1987 and even at the 1988 IWC meeting, where the US commissioner argued that Iceland must submit a new research plan to the IWC and comply with the recommendations of the Scientific Committee before doing any research whaling. When the Soviet Union, Norway and Japan engaged in similar defiance of IWC regulations in recent years, the US certified them.

Iceland made no commitment to halt commercial whaling or to comply with IWC regulations concerning legitimate research. In fact, Iceland announced it would increase the fin whale kill in 1989 to 80 and indicated it would continue "research" whaling indefinitely!

Norway, which was on the verge of ending whaling after the IWC's rejection of its "research" proposal, decided to continue after hearing about the US-Iceland agreement. In fact, Norway made its decision within hours of the Reykjavik announcement.

The Norwegian whalers plan to kill 30 minke whales for commercial consumption (after the "research") and will likely kill another five minke whales when they attempt to anesthetize them to attach radio beacons for tracking.

Iceland continues to ship hundreds of tons of whale meat to Japan from the "research" kills of the big fin and sei whales. In June, a shipment of 197 tons of whale meat was blocked in the Finnish port of Helsinki when Greenpeace protesters charged a violation of Finnish and international bans on trading in endangered species. The Icelandic meat was being routed east on the Trans-Siberian Railway to Japan. Finland ordered the illicit cargo sent back to Iceland.

Japan appealed to the IWC for emergency "relief" for its coastal whalers by calling for a new category of whaling to be established: coastal subsistence. But the IWC flatly rejected the scheme as commercial whaling by another name. The Japanese will attempt to conduct another season of "research" whaling in Antarctica beginning in December. Their ploy is to submit a "new" plan for scientific killing in late 1988 and call for a special meeting of the Scientific Committee to review it. Last year Japan did the same thing, then proceeded to ignore the negative finding of the scientists while sending the whaling fleet south. By the time the full IWC had conducted a postal vote (20 to 6) condemning the Japanese scheme, hundreds of whales had died.

Because of its outlaw whaling Japan's huge fishing fleet was barred from the US 200-mile zone in February. President Reagan refused to embargo Japan's fish but asked for a report by 1 December on Japan's further whaling activities.

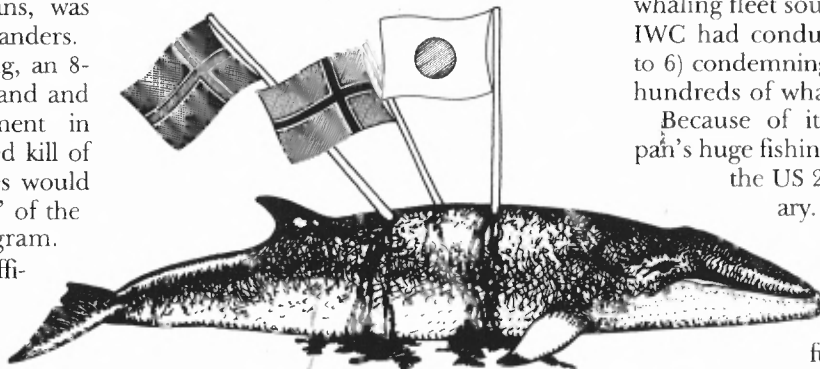

## Staunch friend to whales



Photo: Center for Coastal Studies

Oswaldo Vasquez, a scientist from the Dominican Republic with Humpback whale.

In recent times the Dominican Republic has proved a staunch friend to the whale. In October 1986 the country's ruler, President Balaguer, decreed that Silver Bank, a reef system 60 miles offshore and the world's largest breeding ground for

humpbacks, be made a whale sanctuary.

Since then the Center for Coastal Studies, whose headquarters are in Provincetown, Massachusetts, have been providing on-site training for Dominican marine scientists. And now the latter have discovered that Samana Bay, quite close to Silver Bank, is of peculiar importance to humpbacks.

Many have been sighted there and it is plainly a significant mating ground and nursery for newborn calves.

It is hoped the Dominican government will agree to enlarging the present sanctuary so as to include this bay.

## Dolphins, *continued from page 11*

importation of tuna from countries that fail to reduce dolphin kills to zero, the necessary changes in fishing methods will take place. Sixteen years after the Act was passed it is time for the practice of setting on dolphins to be stopped.

Alternative fishing methods are available. For example, "log fishing" takes advantage of the propensity of yellow fin tuna to gather under logs or other materials floating in the ocean. But the full development of existing aggregating devices for this purpose was abandoned when pressure on the tuna industry lessened after humanitarians and conservationists believed the Marine Mammal Protection Act was progressively increasing protection for dolphins.

**ACTION NEEDED:** Boycott tuna, and tell the manager of the store that you will not buy tuna until the chase and killing of dolphins by tuna fishermen is stopped.

Urge the government to complete the development of aggregating devices to substitute for purse seining. The National Marine Fisheries Service successfully developed the Turtle Excluder Device (TED) to save sea turtles from drowning. It should and could do the necessary technical work to save dolphins from mutilation and drowning.

Commerce Secretary Verity has the power to embargo tuna from countries who flout the Marine Mammal Protection Act. In addition, he can order the National Marine Fisheries Service to reactivate the work on alternative fishing methods.

Write:

Hon. C. William Verity  
Secretary of Commerce  
Washington, D.C. 20230

For full details, send for the 49-page booklet, "The Tragedy Continues: Killing of Dolphins by the Tuna Industry," Earth Island Institute, 300 Broadway, San Francisco, CA 94133 (\$4.95).

## Faroese dolphin hunt

The Faroese Islanders have been killing pilot whales for hundreds of years, and film and photographs of this kill have been shown all over the world. The Environmental Investigation Agency (EIA) has been visiting the Faroese Islands every year since 1984, and has been told on numerous occasions that, as well as pilot whales, the Faroese also kill dolphins, porpoises and killer whales. But it wasn't until 1987 that we actually saw, filmed and photographed a slaughter of dolphins for ourselves.

Special dolphin gaffs were brought out by men on the shore. The killing started when a dolphin tried to jump the net and was hauled into a boat before being knifed to death. A second dolphin suffered the same fate.

Three others were beached, and two men set on each of them with a gaff and knife. One dolphin was attacked by a drunken Faroese man who slashed at its throat with a penknife. Another man took over to finally kill the thrashing animal.

EIA photographers and observers were then attacked by the crowd. With passive resistance we were able to avoid real confrontation until our smallest team member, Vanessa, was grabbed by a drunken man. She tried to pull away but another man also held on to her, trying to prise a camera from her hand. Meanwhile, one of our photographers had the sleeve of his sweater pulled off in a struggle.

Vanessa was dragged around by two drunks and a third man as EIA supporters tried to free her. When she collapsed, pleas to the crowd for a doctor were ignored.

Excerpted from "Dolphin Killing in the Faroes", by Dave Currey in *International Whale Bulletin*, Summer 1988.

## BRAZIL BANS WHALING

Brazil has banned the killing or harassment of all cetaceans. The decree to this effect was signed by President Jose Sarney last December, and it strengthens and supersedes a presidential decree of December 1985 which had banned whaling for five years.

This new law represents the triumph of a 20-year battle by Brazilian conservation groups. They helped draft the original bill introduced two years ago

and turned up in their hundreds at the National Congress in Brasilia to demonstrate against the delaying tactics of Senators from northeastern Brazil where the Japanese-owned whaling company *Copesbra* is based.

Following the demonstration the leaders of all political parties called for an extraordinary session of the Senate and unanimously approved the anti-whaling bill.

## Death in the sun for wild horses as officials blunder

Last September in temperatures of over 90 degrees around 130 wild horses from the Augusta Mountain area of Nevada were rounded up and made to travel some 15 miles to assist the University of Minnesota's fertility control study. The animals were driven by helicopter through a gap in the fence that defines the border of their home range to the study center. Then after field surgery to implant birth control hormones, and after fitting of radio collars, they were released to try to find their own way home.

For 48 of them the return journey was never completed; their corpses were found strung out along the fence by an aerial survey almost a month later. They had died from thirst and exhaustion while vainly searching for the gap. Eight others died slowly and painfully as a result of infection caused by radio collars placed much too tightly around their necks.

The agency responsible for this debacle was the Bureau of Land Management which awarded the million dollar contract to the University of Minnesota

upon recommendation from the National Academy of Sciences. Other more promising fertility studies were passed over in favor of this poorly planned and improperly executed one. The operation violated two fundamental conditions of the study: horses from Augusta Mountain were not supposed to be rounded up at all and no horses were supposed to be driven more than five miles.

Though the Nevada BLM field officials knew that these conditions were being violated, they did nothing to stop the gathering of horses because, according to a report issued by the BLM, "no on-site project inspector was appointed by the Washington Office, therefore impeding clear lines of communication and delegation of authority." The report also blamed all parties involved for poor communications and

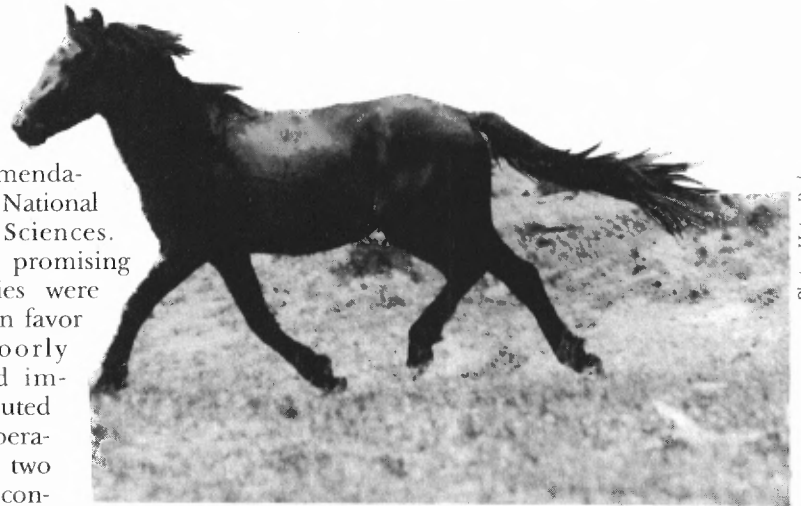

Photo: Hope Ryden

for failing to plan and monitor the herding process.

BLM has admitted blame and, with regard to the research program, has spelt out various changes in procedure which should ensure that in the future there will be no confusion in the chain of command. The agency has, however, rejected the call by six humane organizations, including the American Horse Protection Association, to terminate the University of Minnesota contract and to dismiss the BLM project inspector. The contract stands and there will be no disciplinary action.

## Early neutering: a new solution to an old problem

Pet overpopulation is a critical problem facing animal shelters and one which shows little sign of abating. Most shelters insist that when puppies and kittens are adopted out, they be neutered at six months of age. But many never are.

Why not neuter these animals at the time of their adoption? According to veterinarian Leo Lieberman, neutering animals at two months instead of six months (the generally accepted age) is "not only practical and feasible, it is being done regularly. . . One shelter reduced euthanasia numbers more than 32% over a period of years, which they attribute to the very early age neuter program."

Lieberman's idea is gathering momentum among shelters and veterinarians. His paper, "A Case for Neutering Pups and Kittens at Two Months

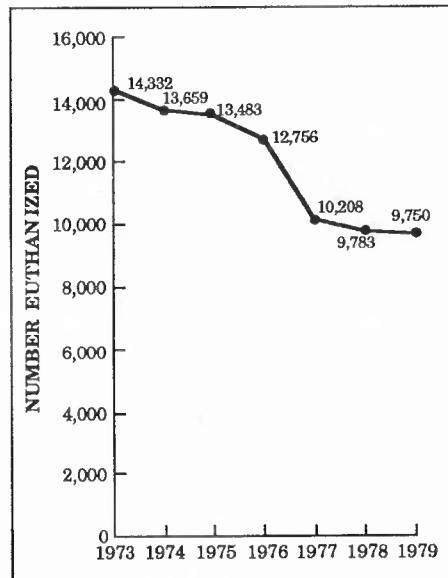

Euthanasia rates in a Medford, OR, SPCA study

of Age" was published in the *Journal of the American Veterinary Medical Association* and was supported by Cornell's *Animal Health Newsletter*.

Besides a reduction in the surplus of animals and the resultant drop in cost to shelters, Lieberman lists other advantages to early neutering: "less stress on the animal and quick recovery; reduced effort and time spent by the surgeon; a people-oriented pet that is more calm, gentler and less likely to wander; reduced aggressiveness; and a reduction of unwanted litters."

As for the disadvantages, Lieberman believes there are few. In fact, in his study of more than 100 pups and kittens which were neutered at eight to ten weeks, he found that "during a two year period. . . undesirable effects were not reported by the owners of such animals."

372



## Lockheed heeds advice

Just occasionally one comes across a company open-minded enough to change course when told of a better way of doing things. Such a company is the aerospace firm, Lockheed, in Burbank, California. A year or so ago AWI learned of the sad story of the Cat Lady of Lockheed and the sad end planned for the feral cats she had befriended for over 30 years.

The company had decided that the cats, though excellent at keeping the rats down, were now so numerous they constituted a hazard to health and safety. A pest control firm was called in—and the Cat Lady, Marie Newberry, was sacked for refusing to stop feeding her animals.

Protests poured in from individuals and local humane groups. Lockheed also received a letter from AWI enclosing a recent *Quarterly* article (see below) on how feral cat populations can be kept within bounds and still be active as rat-catchers. A plea was made too for the Cat Lady to be reinstated so that she could continue her fine feline work.

We have learned that on both counts Lockheed has acted. The cats, now spayed and neutered, have a roofed (and carpeted!) 10-foot-long feeding station and the Cat Lady is back in business.

Whether AWI's letter proved the catalyst that swung Lockheed round we do not know. Nor does it matter. The important thing is that second thoughts have prevailed and sense and sensibility have won. Our compliments to Lockheed!

## Interior ordered to enforce humane rules

*continued from page 1*

The international trade in wild-caught birds has a vast impact on the conservation of wild species by depleting their populations in order to supply the pet market. Senegal alone has an annual bird catch numbering in the millions, many of which die before export. *The Trade in Live Wildlife*, the 1987 Report of Environmental Investigation Agency, states 'Airlines transport the surviving birds to consumer countries. The stress caused in air transportation and quarantine kills at least a further 20% of the birds. Hardly any survive for more than a year. Because of this, the demand for birds continues. The wealthy consumer countries exploit the inability of poorer exporting nations which are unable to adequately control the traders.' The United States is the largest market for these wild creatures. Up to 62% of birds captured in Senegal (the world's largest bird exporter) die prior to departure from the exporting country, according to a Fish and Wildlife Service biologist . . .

Not until November 10, 1987 did the Secretary of the Interior publish final regulations pursuant to the 1981 Lacey Amendments. This was six more years of delay in addition to the 32 years of inaction under the Secretary of the Treasury. During the Secretary of the Interior's recent jurisdiction, the subject of appropriate rules was exhaustively scrutinized. . . .

Thus, thirty-eight (38) years after the Executive Branch was provided authority to publish regulations to assure the humane and healthful transport of wild animals, this country in November 1987 had such a final rule. Those involved in the wild animal trade, as well as air carriers and others, had an opportunity to comment.

Following the November 10, 1987 announcement of the final rule, various

members of the wild animal trade, as well as air carriers and their representatives met privately with the Service and again presented their views for forestalling and altering the final rules. Many if not all of their comments had been presented to the Service during the official comment period provided by the Administrative Procedures Act, including the plea that these regulations would be 'more costly' to the wild animal traders.

Following the above private comments, all occurring after the publication of the final rule, the Service on February 10, 1988 published in the *Federal Register* a new rule postponing the effective date of the November 10, 1987 final rule from February 8, 1988 until August 1, 1988. The stated reason for the post-ponement was concern over 'confusion or misinterpretation' of the November 10, 1987 final rule, which supposedly could lead to shipping practices harmful to the wildlife or impose 'economic hardship on the industry' . . .

At Miami Airport, authorities report that in January and early February, 1988, birds arrived in greatly increased numbers, crammed into small, overcrowded crates, to avoid the impact of the new Rule. These inhumane practices will continue unabated until the Rule on Humane and Healthful Transport of Wild Mammals and Birds is made effective.

On 18 April, 1988, Judge John H. Pratt issued the following decision:

ORDERED that plaintiffs' motion is granted; and it is

ORDERED that defendants shall reinstate the November 10, 1987 Final Rule on Humane and Healthful Transport of Wild Mammals and Birds to the United States, and deem it effective as of February 8, 1988; and it is

ORDERED that the defendants shall be enjoined from further postponing the effective date of the aforementioned rule without complying with the notice and comment requirements of the Administrative Procedures Act; and it is

FURTHER ORDERED that notice of this court's decision shall be published in the *Federal Register*.

The well drafted regulations thus remain in effect to protect birds and mammals.

Interior published a 5-page analysis in the 10 August *Federal Register* of suggested modifications of these rules. AWI is submitting critical comments. Meantime humanitarians are urged to report any mistreatment, overcrowding, or lack of food and water observed on arrival of birds or mammals from foreign countries. Call AWI at 202-337-2332.

## Non-lethal control of feral cats



The Universities Federation for Animal Welfare (UFAW) in England has developed an effective, humane way to control colonies of homeless cats without killing. A videocassette shows the capture of the animals in box traps, neutering, marking, and returning the cats to supervised sites where their long-term care can be assured. The system is being used not only in Britain but in Greece, Kenya, and North Africa by local animal welfare societies.

The videocassette shows a series of color slides narrated by Brian Redhead. It is available in VHS or Betamax, runs for 15 minutes, and costs \$27.00 postage paid to the United States. Copies are available from: UFAW, 8 Hamilton Close, South Mimms, Potters Bar, Herts EN6 3QD, England.

—from Spring/Summer 1987 *Quarterly*

## LABORATORY ANIMAL USE INCREASES

Despite frequent claims by experimental laboratories that they are reducing the numbers of animals used, the report released in July by the US Department of Agriculture shows that numbers of dogs, primates, guinea pigs, hamsters, rabbits and wild animals are increasing. The report is based on documents submitted annually by the laboratories themselves as

required by the federal Animal Welfare Act. According to this information, 1,969,123 animals were used in FY 1987, an increase of nearly 200,000 over the previous year, including the largest number of primates used in over a decade. The report also indicates a marked increase in the number of animals suffering unrelieved pain.

	Fiscal Year 1986	Fiscal Year 1987
DOGS	176,141	180,169
CATS	54,125	50,145
PRIMATES	48,540	61,392
GUINEA PIGS	462,699	538,998
HAMSTERS	370,655	416,001
RABBITS	521,773	554,385
WILD ANIMALS	144,470	168,032
<b>TOTAL</b>	<b>1,778,403</b>	<b>1,969,122</b>
ANIMALS EXPERIENCING UNRELIEVED PAIN OR DISTRESS	113,161	130,373

Figures include only those animals currently protected by the Animal Welfare Act as listed in the chart above.

The US Senate adopted Senator John Melcher's amendment to the Health and Human Services Appropriations bill which prohibits use of US funds to procure wild-caught chimpanzees for research purposes. Labs located outside the US which receive federal funds are subject to the same restriction.

## Cruel lab exposed

An investigation of Biosearch, a testing laboratory in Philadelphia, revealed over 100 alleged violations of state and federal laws including falsification of records and test results; subjecting unanesthetized animals to painful and unnecessary procedures; and failing to provide animals with adequate food, water and veterinary care. People for the Ethical Treatment of Animals conducted the eight month long investigation.

Besides using painful testing methods, including the Draize test and LD 50, animals were often totally neglected. According to an investigator, a guinea pig who appeared to have a spinal cord injury "was whimpering and could not stand or lift his head up. His eyes were half closed and he was lying in his own feces which covered his hind quarters. When I picked him up to weigh him his body was limp and he was whimpering. (Employee) said he could have been destroyed yesterday when it was noticed, but that everybody was too busy to weigh him and he had to be weighed before being killed." Another group of guinea pigs were "screaming all day long" after a dermal test was performed.

A videotape distributed by PETA documents cruel and needless tests. It shows rabbits with holes burned deeply into their bodies during tests of a product already known to be corrosive. According to the investigator's report, technicians had been warned to wear gloves when handling it. It further states that the rabbits screamed and struggled so violently two employees had to hold them when the bandages that kept the burning substance in place were unwrapped.

Biosearch conducts consumer, cosmetic and household product testing for over 200 companies, including Estee Lauder, L'Oreal, Noxell, Revlon, Benetton, A.H. Robins, S.C. Johnson, Procter & Gamble, and Mennen.

## Appropriations Committee calls for action on Animal Welfare regulations

(From *Senate Report on the Agriculture, Rural Development, and Related Agencies Appropriations Bill, 1988*)

*Animal Welfare Act*—For enforcement of the Animal Welfare Act, the Committee recommends \$6,197,000, an increase of \$1,275,000 over the budget request, and the same as the House and 1988 levels. This amount is actually a \$750,000 increase over the 1988 level because the Committee does not recommend a transfer of this amount to the National Agricultural Library [NAL] for the information service. Rather, funding for this service is included in the NAL account.

The Committee wishes to express strong support for the APHIS animal welfare inspection program and its commitment to ensuring that both human and animal health and welfare will continue to advance through humane and responsible animal research.

The Committee has included additional funds in the bill to enhance the animal welfare program through increased frequency of inspections and inspector training. The Committee expects that a portion of these funds will be directed toward developing and implementing a comprehensive training program to provide inspectors of research facilities with basic competence in laboratory animal medicine, knowledge of animal behavior typical of the different species used in research and an appreciation of both scientific methods and animal welfare. Through this training, the Committee expects that the agency will better fulfill its responsibility to carry out adequate and regular inspections of facilities.

The Committee is concerned by the long delay in publishing final regulations for enforcement of the Improved Standards for Laboratory Animals amendments to the Animal Welfare Act passed in 1985 (effective date, December 23, 1986) and expects expeditious action on the final regulations so that the law can take effect before the end of calendar year 1988.

## Animal Incident Report Form

**ANIMAL INCIDENT REPORT**

DATE OF INCIDENT:     
Day Mo Yr

TIME OF INCIDENT:      
Hour Min. A.M. P.M.

SPECIES: \_\_\_\_\_ ANIMAL TAG NO. \_\_\_\_\_ PROTOCOL NO. \_\_\_\_\_  
DISCOVERED BY: \_\_\_\_\_ You may choose to be anonymous  
WITNESSED BY: \_\_\_\_\_  
LOCATION OF INCIDENT: \_\_\_\_\_  
TYPE OF INCIDENT (specify): \_\_\_\_\_

**SURGICAL**

PAIN  
 INADEQUATE ANESTHESIA  
 POOR POST-OP CARE  
 INCISION DEHISCED

**POST-SURGICAL**

GROSS WOUND INFECTION  
 ANIMAL MORIBUND  
 HEMORRHAGE  
 OTHER (specify) \_\_\_\_\_

COMMENT: \_\_\_\_\_

**ANIMAL CARE:**

UNSANITARY CONDITIONS  
 INADEQUATE TRANSPORTATION  
 LACK OF FOOD AND WATER  
 OTHER (specify) \_\_\_\_\_

CROWDING  
 ABUSE  
 POOR ANIMAL CARE

COMMENT: \_\_\_\_\_

A useful form to facilitate prompt reporting on laboratory animals in trouble is included in *Guidelines for Lay Members of Animal Care Committees*, published by the Canadian Federation of Humane Societies (September 1986). The content of the form appears at left in its entirety. (The original, of course, is less compressed, allowing space for comments.)

## Biohazardous Baylor

It appears that cleaning up its act is proving no simple matter for Baylor College of Medicine. Following AWI's documentation of the disgusting conditions in a cancer laboratory at the College (see last issue of the *Quarterly*) we were told that matters had greatly improved. But in March an inspector from the area's pollution control agency found large amounts of biohazardous waste, some of it of a singularly distasteful nature and much of it not even wrapped in biohazard bags, dumped at a local landfill. Numerous bits of correspondence on Baylor letterhead plainly revealed the culprit.

On being apprised that the college would shortly be on the receiving end of a formal citation, Baylor Vice President and Dean for Academic and Clinical Affairs put out an urgent memorandum to all department chairmen and administrators. "I am sure you are aware of the very sensitive nature of this type of discovery if distributed in the public media," he wrote, "Please give this your immediate attention." Faculty with questions were advised to consult "Guidelines for Laboratory Use of Infectious Agents, Oncogenic Viruses, and Chemical Carcinogens."

## Fines for violations of the Animal Welfare Act

### University of Minnesota

Charged by USDA with operating substandard research facilities, the University of Minnesota has agreed to pay a \$5000 fine and to cease and desist from future violations of the Animal Welfare Act. The University has also agreed to place all animal facilities under strong professional veterinary direction, to establish a training program to ensure all personnel are aware of the Act's requirements and to allocate substantial capital for the replacing of equipment and the hiring of sufficient support staff.

### Louisiana State University

Louisiana State University paid a \$6,000 penalty in April for violations of the Animal Welfare Act. The violations date back to 1985 when on four occasions, US Department of Agriculture inspectors found inadequate housing, sanitation and veterinary care.

The violations included housing ani-

mals in unsound facilities and in cages that are too small for normal postural adjustments, neglecting to provide clean food containers or enough water, and employing insufficient staff to care for the animals.

The University agreed to maintain an institutional animal care committee and submit a written report to USDA within 60 days detailing their plans to comply with the Animal Welfare Act.

USDA inspection reports going back to 1981, documented in AWI's 1985 book, *Beyond the Laboratory Door*, reveal major problems with the housing and care of animals at Louisiana State. In fact, some deficiencies were left uncorrected for five years until USDA finally threatened to file a case against them in 1984.

### Record penalty upheld

A federal judge upheld a \$40,000 penalty against James Hickey, an Oregon animal dealer, following his appeal. The decision, which also called for suspension of Hickey's federal license for

25 years and a cease-and-desist order against future violations, was the highest ever imposed for violations of the Animal Welfare Act.

In a decision signed May 27, the judge found that Hickey, doing business as S&S Farms and also as S.S. Farms, Inc., grossly neglected to comply with housing, sanitation and veterinary care standards for dogs and cats kept at his commercial facility. (See *AWI Quarterly*, 36, #3)

He also found that Hickey falsely reported the dollar amount of sales on his annual license renewal report for 1984, deliberately refused inspectors and law enforcement officers access to his business records in 1985 and consistently showed false and misleading information on the description, number and origin of dogs and cats he acquired and sold to registered research facilities, thereby concealing the source of stolen and fraudulently obtained pets found on his premises.

# Undercover operations surface triumphantly

On the morning of 24 February nearly 100 Fish and Wildlife Service agents moved in to make arrests across 12 states from Alaska down to Texas, so bringing a 4-year "sting" to a successful conclusion.

Targeted initially at law-breaking guides offering "guaranteed hunts" (one reputedly earned \$50,000 in a week from clients paying up to \$10,000 for brown bears), the Service set up its undercover stall as *Abrams Creek Outfitters* in Purcellville, Virginia. It operated as a booking agency through which hunters could arrange big-game expeditions.

One nasty illegality exposed was the poaching of black bears in the southern Appalachians including the Shenandoah National Park. Hides were being sold for up to \$250 each and gallbladders for a lot more.

Another prime center of investigation was Alaska, following reports of airborne hunting and out-of-season killing of caribou and brown bears. The reports proved all too true. Aircraft were being used to herd animals towards the hunters in violation of the Airborne Hunting Act.

The conclusion to a separate undercover operation which spanned almost two years was announced on 1 March. In what was described as "one



Clark Bavin, chief of Fish and Wildlife Law Enforcement, is surrounded by the confiscated wildlife products seized in the sting.

of the largest investigations of its kind in the western United States," agents of California's Fish and Game Department arrested 52 alleged black bear poachers and dealers. With each bear carcass potentially worth more than \$800 to the poacher—through the separate selling of the various parts of the animal—illegal kills in northern California are thought to number two or three times the figure for legal kills.

Among those arrested were 23 Asian

herbalists whose Chinese and Korean customers will pay as much as \$540 an ounce to acquire the alleged rejuvenating properties inherent in the bear's gallbladder. It transpired, though, that around 90% of the gallbladders sold in these stores at sky-high prices came from pigs and cows. The fraudulent nature of this racket is being widely publicized by Fish and Game in the hope that it will dampen the enthusiasm of potential buyers.

## Very special agents join war on drugs

Federal agents Barco, Duko and Rocky have in the past year unearthed \$100 million worth of heroin, cocaine and marijuana, and helped jail more than 100 smugglers. Compare this haul with the \$600 worth of drugs seized during the same period by the entire (Mexican) Border Patrol of 3200 agents and it is plain that Barco, Duko and Rocky must be very special agents.

They are! They are canine agents, star members of a team of 20 Belgian Malinois dogs specially trained to sniff out drugs. 1987 was their first year in action—and already they have spread alarm and despondency in the enemy ranks. So much so that there is reportedly a \$30,000 price tag on their heads with the bounty being brazenly advertised in a Mexican newspaper.

The three stars are accordingly given

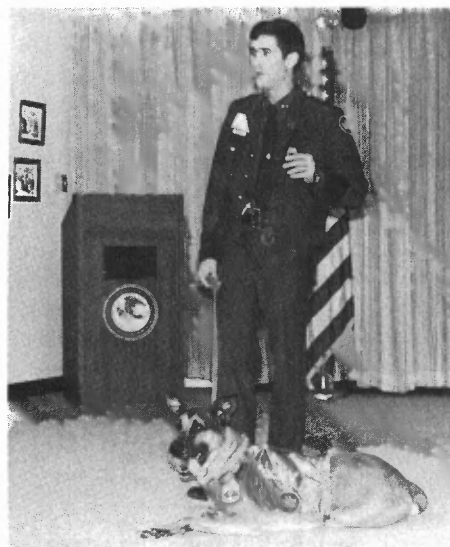

Special agent Rocky of the Border Patrol with his handler.

top security treatment. They sleep in electronically protected quarters and will accept food only from their handlers. Furthermore, one of the three, Barco, now wears a bullet-proof vest. If he shows this 70lb garment in no way mars his performance in 110 degree heat, then his two co-stars will be similarly garbed.

The three dogs were received by Nancy Reagan on 11 May and the Senate unanimously agreed that a *Washington Post* article on their exploits should be printed in the *Congressional Record*.

Canine agents have scored successes for USDA, too, but have not been drafted to use their superior olfactory powers to help curb the multimillion dollar wildlife smuggling racket.

# Adele Schoepperle

## 1906-1988

She was born in Rhode Island; but her father's business kept the family moving from one place in New England to another, and she had in consequence a rather scattered education. Interested in the drama from an early age, she somehow managed at the age of eighteen to land a part in the 1924 Broadway production of Stephen Phillip's *Paola and Francesca*. She also had a role in *The Trial of Mary Dugan*, a big thriller in its day. But when the Depression set in, she found work in John Campbell's rare book store in Rittenhouse Square, Philadelphia, where, since there were very few customers then, there weren't many weekly paychecks either, and Mr. Campbell was often reduced to paying his employee with books. Still it was just possible in those days, by taking one's meals in Horne and Hardart's automat, to live on a very small amount of money. The book shop constituted a tiny cultural center for semi-employed writers and collectors who had plenty of time to settle the issues of the day. Above the shop lived a couple of musicians of the Philadelphia Orchestra from whom Adele received free lessons until, it seems, she could play badly enough to join The Silly Symphony, a local music group that did their work with great enthusiasm. She also joined the Chestnut Hill Players, and then the Hedge-row, devoted as it was and still is, to presenting those plays that represent "the best that has been thought and said in the world," was as a result unable to pay any but the most essential expenses; and then World War II made matters still more difficult for everyone, and Adele migrated to New York



Adele in *Paola and Francesca*

City to find a paying job. This turned out to be with the Dutch Information Service, tending their mailing list. In fact, it was her fate, she said, wherever she went, to end up doing the mailing list. It was at this time she changed her name to Mrs. John Schoepperle, and then, some time after the war, moved with her husband to White Plains and was soon immersed in animal work—first, a lost-and-found service for lost and found pets, then a long stint with The S.P.C.A. of Westchester, then a local radio program about advice on animals, and finally work for The Animal Welfare Institute, for which organization she again did (among other things) the mailing list.

—John Schoepperle

*Adele Schoepperle, who died this winter had been associated with the Institute almost since its founding in 1951. She wore many hats, finally being named Assistant Treasurer, but all her assignments reflected her careful and painstaking approach to even the most mundane and demanding tasks involved in keeping an understaffed and overburdened office functioning smoothly. The following resolution passed by acclamation at the meeting of the AWI Board reflects the respect and affection Adele inspired.*

"In view of the long association and selfless service by Adele Schoepperle to the Animal Welfare Institute, the Board of Directors extends to John its deepest and most heartfelt gratitude for her unceasing labor on behalf of all animals, her cheerful and buoyant attitude toward her work and the high quality of her precise and encyclopedic grasp of her duties."

### Animal Welfare Institute

#### Scientific Committee

Marjorie Anchel, Ph.D.  
Bennett Derby, M.D.  
F. Barbara Orlans, Ph.D.  
Roger Payne, Ph.D.  
Samuel Peacock, M.D.  
John Walsh, M.D.

#### International Committee

Aline S. de Aluja, D.V.M.—Mexico  
T.G. Antikas, D.V.M.—Greece  
Ambassador Tabarak Husain—Bangladesh  
Angela King—United Kingdom  
Simon Muchiru—Kenya  
David Ricardo—Canada  
Godofredo Stutzin—Chile  
Klaus Vestergaard—Denmark

#### Officers

Christine Stevens, President  
Cynthia Wilson, Vice President  
Marjorie Cooke, Secretary  
Roger L. Stevens, Treasurer

#### Directors

Madeleine Bemelmans  
Gerard Bertrand, Ph.D.

#### Directors, cont'd

Marjorie Cooke  
Christabel Gough  
David O. Hill  
Sue Hunt  
Freeborn G. Jewett, Jr.  
Christine Stevens  
Aileen Train  
Cynthia Wilson

#### Staff

Patrick Allen, Editorial Consultant  
Jessie Despard, Publications Coordinator  
Rose R. Eck, Administrative Assistant  
for Communications

Diane Halverson, Research Associate  
for livestock and poultry  
Lynne Hutchison, Whale Campaign Secretary  
Cathy Liss, Research Associate

Nell Naughton, Mail Order Secretary  
Greta Nilsson, Wildlife Consultant  
Victor Perez, Clerical Assistant  
Laura Swedberg, Administrative Assistant  
Louise Wright, Research Assistant

## Periodical Pleasures

Today, when there is so much interest in the work that can be done to alleviate the plight of homeless animals, it is a salutary shock to read in the July 24, 1988 issue of the *New York Times* about Rick Caron who bears the dread title of Dogcatcher (remember the villain of our youth) and goes about his duties with compassion and a single-minded devotion.

His base is a metropolis in Maine

named Jay (population 5068, Zip Code #04239), and he routinely captures strays from Jay and six surrounding communities. Unable to bring himself to adhere to the established practice of a few days of incarceration followed by death, he is currently hosting about 40 dogs, 15 cats and such transients as a pigeon and a raccoon in a shelter he used his savings to build. I don't know how spacious the guest quarters are, but they are there, open and filled with love.

There is a Mrs. Caron who must catch occasional glimpses of her hus-

band as he goes about his dogcatching duties and works two other jobs to help meet expenses.

It's nice to report that situations like this bring out the best in so many people. A media favorite, high-fashion titan has donated, without fanfare, enough money "to buy us food for a year" according to grateful Rick Caron, the size of whose heart is matched only by the strength of his stamina.

—John Gleiber

### Drugs in the bullring

The Spanish bullfight is not just a sickening spectacle, but often a fraudulent one as well. An article in Spain's chief national daily, *El Pais*, reveals how a Madrid veterinarian, his suspicions aroused by the bizarre behavior of bulls in the bullring, found they had been drugged.

Post-mortem analysis showed that one group of animals, suffering from severe lack of coordination, had each received some



25 kilograms of Epsom salts — where four or five kilograms is, in the words of the vet, "a brutal dose". Another group had been tranquilized and yet another rendered virtually blind by (probably) a chemical sprayed moments before the fight.

Will these revelations prove the death blow to any lingering romance still attaching to the bullfight? Let us hope so.

### Senate passes Pet Theft Act of 1988

A new version of the Pet Theft Act, introduced by Senators Wendell Ford (D-KY), Patrick Leahy (D-VT), Robert Dole (R-KS), and Kent Conrad (D-ND) was passed by the US Senate 10 August. It now goes to the House Agriculture Committee for action.

Senator Ford, speaking for his bill on the Senate floor said, "The problem of pet theft is so pervasive, occurring in every jurisdiction, and because no responsible researcher wants anything to do with stolen animals, I look forward to swift passage of this legislation."

Agriculture Committee Chairman Leahy stated, "This legislation bans auction sales of animals for research purposes and would thereby eliminate the abduction of pets in our neighborhoods."

Animal Welfare Institute  
P.O. Box 3650  
Washington, D.C. 20007

Non-Profit Org.  
U.S. POSTAGE

**PAID**

Washington, D.C.  
Permit No. 2300